



BID NUMBER: LDPWRI-B/20359

**APPOINTMENT OF CONTRACTOR FOR CONSTRUCTION OF NEW
MANKWENG TRADITIONAL COUNCIL OFFICES THROUGH THE
FRAMEWORK CONTRACT CATEGORY B**

for the

**THE DEPARTMENT OF COOPERATIVE GOVERNANCE, HUMAN
SETTLEMENTS AND TRADITIONAL AFFAIRS
LIMPOPO PROVINCE**

Issued by:

Limpopo Department of Public Works, Roads and Infrastructure
Works Towers Building
43 Church Street
Polokwane
0700

Contact Person: General Queries

Name : Mr NJ Motsopye,
Tel No. : 015 284 7126
Email : motsopyen@dpw.limpopo.gov.za

Technical: Technical Queries

Name : Mr. Maluleke ZV
Tel No. : 015 284 7219
Email : MalulekeZV@dpw.limpopo.gov.za

Name of the Bidder :

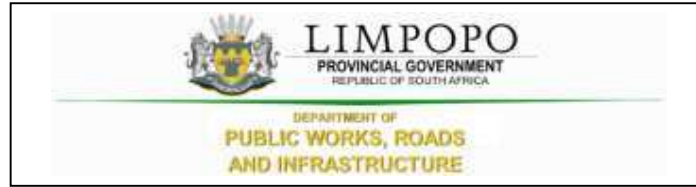

CONTENTS

THE TENDER

Part T1: Tendering procedures

- T1.1 Tender notice and invitation to tender
- T1.2 Tender data

Part T2: Returnable documents

- T2.1 List of returnable documents
- T2.2 Returnable schedules

THE CONTRACT

Part C1: Agreements and Contract data

- C1.1 Form of offer and acceptance
- C1.2 Contract data
 - Joint Venture Agreement (If Applicable)

Part C2: Pricing data

- C2.1 Part 1 - Pricing Instructions
- C2.2 Part 2 - Bills of Quantities

Part C3: Scope of Works

- C3.1 Special Notes to Bidders
- C3.2 OHS Specifications

Part C4 Drawings

Bidder's initials

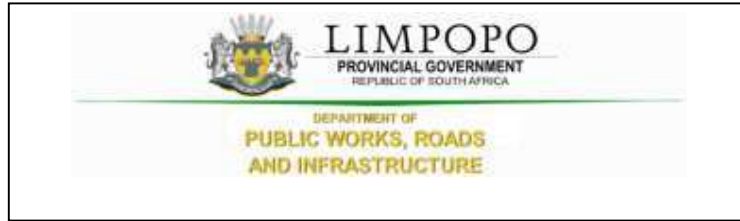

PART T1: TENDERING PROCEDURE

Bidder's initials

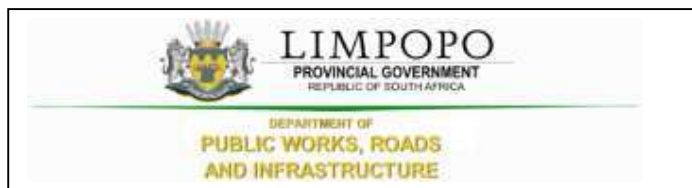

T1.1 Tender Notice and Invitation to Tender

The Limpopo Department of Public Works, Roads and Infrastructure invites tenderers from contractors appointed on the framework agreement on category B for **CONSTRUCTION OF A NEW MANKWENG TRADITIONAL COUNCIL OFFICE** for a period of 12 months. It is estimated that tenderers must have a CIDB contractor grading designation of **6 GB** or higher.

The conditions of the CIDB Standard for Indirect Targeting for Enterprise Development through Construction Works Contracts **Gazette Notice No. 36190 of 25 February 2013** will be applicable on this project

Project Name	CONSTRUCTION OF NEW MANKWENG TRADITIONAL COUNCIL OFFICE for a period of 12 months.	
Tender Number	LDPWRI-B/20359	
Tender documents availability	Limpopo Department of Public Works, Roads and Infrastructure website	
Address for submission of tenders	DEPARTMENT OF PUBLIC WORKS, ROADS & INFRASTRUCTURE. Physical address: Corner River and Blaauwberg Streets, Ladanna, 0699.	
Closing date of the tender	As per Tender invite	
Closing time of the tender	As per Tender invite	
Compulsory briefing meeting (<i>Tenderers must sign the attendance register in the name of the tendering entity. Addenda (if any) will be issued only to those tendering entities appearing on the attendance register</i>)	Yes <input checked="" type="checkbox"/> No <input type="checkbox"/>	
	Meeting venue	As per Tender invite
	Date	As per Tender invite
	Time:	As per Tender invite
Evaluation criteria	<ol style="list-style-type: none"> 1. Compliance with mandatory or compulsory requirements 2. Risk assessment on current projects 3. Price 4. Preference 	
Mandatory or Compulsory Requirements (<i>failure to submit or comply with these requirements will lead to automatic disqualification</i>)	Only tenderers who are appointed on category B registered with the Construction Industry Development Board (CIDB) with designation of 6GB or higher than a contractor grading designation determined in accordance with the sum tendered, or a value determined in accordance with Regulation 25 (1B) or 25(7A) of the Construction Industry Development Regulations are eligible to have their tenders evaluated Completed and signed Form of Offer	

Bidder's initials

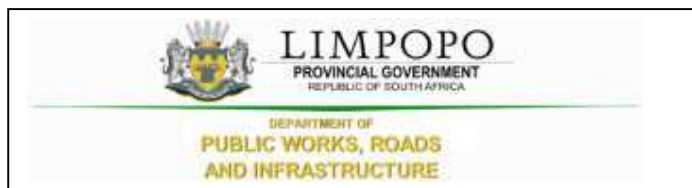

T1.2 Tender Data

Clause number	Tender Data
	<p>The conditions of tender are the Standard Conditions of Tender as contained in Annex C of Board Notice 423 of 2019 in Government Gazette No. 42622 of 08 August 2019, Construction Industry Development Board (CIDB) Standard for Uniformity in Construction Procurement. (See www.cidb.org.za) which are reproduced without amendment or alteration for the convenience of tenderers as an Annex to this Tender Data.</p> <p>The Standard Conditions of Tender make several references to the Tender Data for details that apply specifically to this tender. The Tender Data shall have precedence in the interpretation of any ambiguity or inconsistency between it and the standard conditions of tender. Each item of data given below is cross-referenced to the clause in the Standard Conditions of Tender to which it mainly applies.</p> <p>The contractor shall achieve in the performance of the contract the Contract Participation Goals (CPG) relating to the engagement of targeted enterprises as established in the CIDB Standard for Indirect Targeting for Enterprise Development through Construction Works Contracts Gazette Notice No. 36190 of 25 February 2013. In this case, contractor shall provide a minimum Contract Participation Goal (CPG) of 5% of the total project value and develop targeted enterprises stated under C3 of this document.</p> <p>The following variations, amendments and additions to the Standard Conditions of Tender as set out in the Tender Data below shall apply to this tender. Add the following to clauses in Standard Conditions of Tender:</p>
C.1.1	The Employer is the Department of Public Works, Roads and Infrastructure
C.1.2	<p>The Tender Part T1: Tendering procedures T1.1 Tender notice and invitation to tender T1.2 Tender data</p> <p>Part T2: Returnable documents T2.1 List of returnable documents T2.2 Returnable schedules</p> <p>The Contract Part C1: Agreements and contract data C1.1 Form of offer and acceptance C1.2 Contract data C1.3 Joint Venture Agreement (If Applicable)</p> <p>The Contract Part C2: Pricing data C2.1 Pricing instructions C2.2 Bills of Quantities</p> <p>Part 3: Scope of work C3.1 Special Notes to Bidders C3.2 OHS Specifications</p> <p>Part 4: Site information C4 Drawings</p>

Bidder's initials

**CONSTRUCTION OF NEW MANKWENG TRADITIONAL COUNCIL OFFICES FOR THE LIMPOPO DEPARTMENT OF COOPERATIVE GOVERNANCE, HUMAN SETTLEMENTS AND TRADITIONAL AFFAIRS
CONTRACT No. LDPWRI-B/20359**

C.1.4	<p>The employer's representative is :</p> <p>Name : Tel No. : Email :</p> <p>However, all communications related to this bid should be directed to the persons indicated under Enquires on this tender document.</p> <p>Attention is also drawn to the fact that verbal information, given by the Employer's agent during site visits/clarification meetings or at any other time prior to the award of the Contract, will not be regarded as binding on the Employer. Only information issued formally by the Employer in writing to Tenderers will be regarded as amending the Tender Documents</p>
C.1.5	The employer reserve to cancel the tender prior to the award of the tender.
C1.6.2	A competitive negotiation procedure will not be followed.
C1.6.3	A two-stage system will not be followed.
C.2.1	<p>Eligibility in respect of CIDB grading</p> <p>Only tenderers who are appointed on framework agreement category A and registered with the Construction Industry Development Board (CIDB) with designation of 6 GB or higher than a contractor grading designation determined in accordance with the sum tendered, or a value determined in accordance with Regulation 25 (1B) or 25(7A) of the Construction Industry Development Regulations, are eligible to have their tenders evaluated</p>
C2.2	<p>Cost of tendering</p> <p>The tenderer accept that, unless otherwise stated in the tender data, the employer will not compensate the tenderer for any costs incurred in the preparation and submission of a tender offer, including the costs of any testing necessary to demonstrate that aspects of the offer complies with requirements</p>
C.2.7	<p>Compulsory site briefing</p> <p>A compulsory briefing meeting will be held as per Tender invite</p> <p>Tenderers must sign the attendance list in the name of the tendering entity. Addenda (if any) will be issued only to those tendering entities appearing on the attendance list</p>
C.2.11	<p>Alterations to the documents</p> <p>Bidders are required to not make any alterations or additions to the tender documents, except to comply with instructions issued by the employer, or necessary to correct errors made by the tenderer. All signatories to the tender offer shall initial all such alterations</p>
C.2.12	<p>Alternative tender offer</p> <p>No alternative tender offer is permitted in this tender.</p>
C.2.13.2	<p>Replace sub-clause C.2.13.2 with the following; Return all returnable documents to the employer after completing them in their entirety by writing in non-erasable black ink</p>
C.2.13.3	Parts of each tender offer communicated on paper shall be submitted as an original

Bidder's initials

**CONSTRUCTION OF NEW MANKWENG TRADITIONAL COUNCIL OFFICES FOR THE LIMPOPO DEPARTMENT OF COOPERATIVE GOVERNANCE, HUMAN SETTLEMENTS AND TRADITIONAL AFFAIRS
CONTRACT No. LDPWRI-B/20359**

C.2.13.4	The tender shall be signed by a person duly authorized to do so.
C.2.13.5	The employer's details and address for delivery of tender offers and identification details that are to be shown on each tender offer package are: Location of tender box: DEPARTMENT OF PUBLIC WORKS, ROADS & INFRASTRUCTURE. Physical address: Corner River and Blaauwberg Streets, Ladanna, 0699 Identification details: Sealed Tender with Tender reference number, Title of Tender and the closing date and time of the tender.
C.2.15.1	The closing time for submission of tender offers is as stated in the Tender Notice and Invitation to Tender. Telephonic, telegraphic, telex, facsimile or e-mailed tender offers will not be accepted.
C.2.16.1	The tender offer validity period is 12 weeks or 90 days .
C.2.16.2	The tender accepts that a tender submission that has been submitted to the employer may only be withdrawn or substituted by giving the employer's agent written notice before the closing time for tenders that a tender is to be withdrawn or substituted. If the validity period stated in C.2.16 lapses before the employer evaluating tender, the contractor reserves the right to review the price based on Consumer Price Index (CPI).
C.3.1	The tenderer is required to indicate how they claim points for each preference point system and attached relevant supporting documents. The specific goals for claiming of preference points include the following: <ul style="list-style-type: none"> - Persons who had no franchise in national elections prior to 1983 and 1993 - Women - Disabled persons - Promotion of SMMEs - Enterprise located in Limpopo Province - Promotion of youth
	<i>CIDB Grading Certificate</i> Tenders are required to provide proof of registration with the CIDB register of contractors indicating the category of registration, grading as well as the CRS number of the tenderer. <i>Letter of Good Standing</i> Tender are required to submit, bound with the tender submission, a letter of good from the compensation commissioner indicating that the bidder is in good standing.
C3.2	Notwithstanding any requests for confirmation of receipt of Addenda issued, the tenderer shall be deemed to have received such addenda if the employer can show proof of transmission thereof (or a notice in respect thereof) via electronic mail, facsimile or registered post.
C.3.4.1	Tenders will not be opened immediately after the closing time for tenders.

Bidder's initials

**CONSTRUCTION OF NEW MANKWENG TRADITIONAL COUNCIL OFFICES FOR THE LIMPOPO DEPARTMENT OF COOPERATIVE GOVERNANCE, HUMAN SETTLEMENTS AND TRADITIONAL AFFAIRS
CONTRACT No. LDPWRI-B/20359**

<p>C.3.11</p>	<p>The tenderers will be evaluated in four stages</p> <ul style="list-style-type: none"> (i) Stage 1: Compliance with mandatory requirements as stated in Part T1.1 (ii) Stage 2: Risk assessment on current projects (iii) Stage 3: Price (iv) Stage 4: Preference <p>The technical capacity (functionality) of the contractors will not be evaluated any further during evaluation of the RFQ. However, the contractors will be required to declare the status of their key staff and any administrative compliance. In cases where there are changes in the key staff, the contractor should provide CVs and qualifications of the new staff to LDPWRI. The new staff should have similar skills, qualifications and experience as the staff submitted during tender. Similarly, the contractors will be expected to provide an update on any changes in their administrative compliances – and should submit the required SBD document in such cases.</p> <p>The award will only be issued to contractors with valid Tax Clearance certificates, active CIDB grading and the contractor who meets all the legislative requirement – this shall be verified by SCM in line with the departmental SCM Policy.</p> <p>The total value of current projects for a contractor under consideration cannot exceed the twice the maximum value of their relevant CIDB grade.¹</p>
	<ul style="list-style-type: none"> a) Stage 1: Administrative Compliance: The Compliance or compulsory documents and returnables are detailed in Section T.2.1 of this tender document. Failure to submit, complete or comply with these requirements will lead to automatic disqualification. b) Stage 2: Risk assessment on current projects <p>The total value of current projects for a contractor under consideration cannot exceed the twice the maximum value of their relevant CIDB grade.</p>

Bidder's initials

Stage 3 and 4:

The procedure for final evaluation of responsive tenders is Method 2 (Financial offer and preference). The total number of tender evaluation points (T_{EV}) shall be determined in accordance with the following formula.

$$T_{EV} = N_{FO} + N_P$$

- a) N_{FO} is the number of tender evaluation points awarded for the financial offer made. The score for financial offer is calculated using the following formula:

$$P = A * \left(1 - \frac{(P_o - P_m)}{P_m}\right)$$

Where:

A is 80 since the estimated financial value of works inclusive of VAT is equals or is less than R 50,000,000.00.

P is the points awarded to the bid under consideration

P_m is the lowest Comparative bid price

P_o is the comparative price under consideration

N_P is the number of tender evaluation points awarded for preferences claimed in accordance with the Preferencing Schedule in 3.18

Bidder's initials

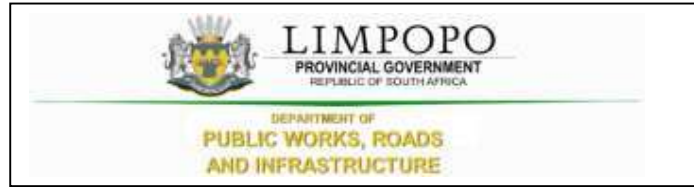

PART T2: RETURNABLE DOCUMENTS

Bidder's initials

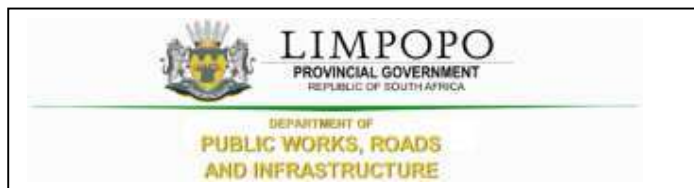

T2.1 : LIST OF RETURNABLE DOCUMENTS

The following documents will form part of the documents submitted to the Contractors as part of the Request for Proposals:

- 2.1 Fully completed Form of Offer
- 2.2 Bills of Quantities
- 2.3 Proof of specific goal for award of the preference points as determined on the Request for Proposal
- 2.4 SBD 6.1.
- 2.5 Declaration on the status of Administration compliance.
- 2.6 CIDB grading certificate
- 2.7 CSD Report
- 2.8 Tax clearance certificate
- 2.9 Declaration of current projects

Failure by the service provider to submit or complete item 2.1 or 2.2 will render their proposal not responsive and will not be considered.

The bidder should also not appear on the National Treasury's list of black listed entities

Bidder's initials

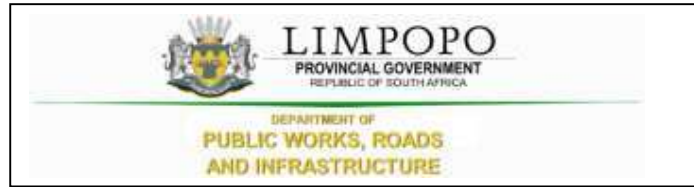

T 2.2 : RETURNABLE SCHEDULE

	Document Name	Returnable document
1.	Preferencing schedule:	<input type="checkbox"/> Yes <input type="checkbox"/> No
2.	Proposed amendments and qualifications (if applicable)	<input type="checkbox"/> Yes <input type="checkbox"/> No
3.	SBD 1: Invitation to tender	<input type="checkbox"/> Yes <input type="checkbox"/> No
4.	SBD 6.1: Reference Points claim form in terms of the Preferential Procurement Regulations 2017 or amended	<input type="checkbox"/> Yes <input type="checkbox"/> No
5.	Form of offer	<input type="checkbox"/> Yes <input type="checkbox"/> No
6.	CSD summary report	<input type="checkbox"/> Yes <input type="checkbox"/> No
7.	Original tax clearance certificate or tax pin	<input type="checkbox"/> Yes <input type="checkbox"/> No
8.	Priced bills of quantities	<input type="checkbox"/> Yes <input type="checkbox"/> No
9.	Proof of CIDB class grading: 6GB or higher.	<input type="checkbox"/> Yes <input type="checkbox"/> No
10.	Declaration with regard to current projects	<input type="checkbox"/> Yes <input type="checkbox"/> No

Bidder's initials

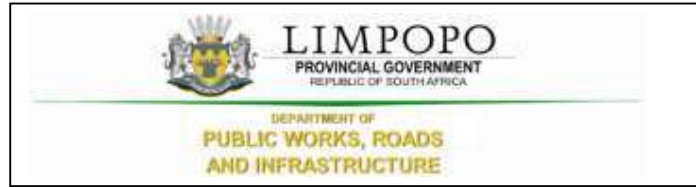

Declaration on the status of administrative compliance

Please indicate, by circling either **Yes** or **No**, whether the administrative information submitted with the original framework tender documents has changed or not. If yes, kindly provide the particulars below and any supporting documents.

.....

.....

.....

.....

Signed Date

Name Position

Enterprise
.....

Bidder's initials

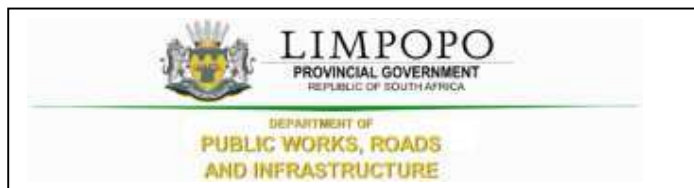

Record of Addenda to tender documents

We confirm that the following communications received from the Employer before the submission of this tender offer, amending the tender documents, have been taken into account in this tender offer:

	Date	Title or Details
1.		
2.		
3.		
4.		
5.		
6.		
7.		
8.		
9.		
10.		

Attach additional pages if more space is required.

Signed Date

Name Position

Tenderer

Bidder's initials

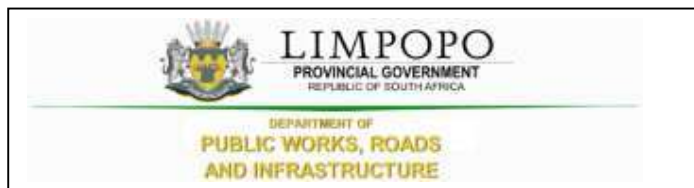

Proposed amendments and qualifications

The Tenderer should record any deviations or qualifications he may wish to make to the tender documents in this Returnable Schedule. Alternatively, a tenderer may state such deviations and qualifications in a covering letter to his tender and reference such letter in this schedule.

The Tenderer's attention is drawn to clause 5.8 of SANS 10845-3 regarding the employer's handling of material deviations and qualifications.

Page	Clause or item	Proposal

Signed _____ Date _____
 Name _____ Position _____
 Tenderer _____

Bidder's initials

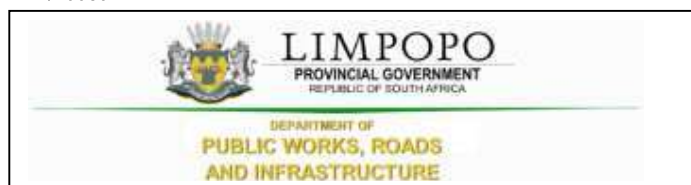

SBD 1

PART A: INVITATION TO BID

YOU ARE HEREBY INVITED TO BID FOR REQUIREMENTS OF THE LIMPOPO DEPARTMENT OF PUBLIC WORKS, ROADS AND INFRASTRUCTURE					
BID NUMBER:	LDPWRI-B/20359	CLOSING DATE	As per Tender Advert	CLOSING TIME:	11:00am
DESCRIPTION	CONSTRUCTION OF NEW MANKWENG TRADITIONAL COUNCIL OFFICES IN THE CARPRICORN DISTRICT				
BID RESPONSE DOCUMENTS MAY BE DEPOSITED IN THE BID BOX SITUATED AT (STREET ADDRESS)					
DEPARTMENT OF PUBLIC WORKS, ROADS & INFRASTRUCTURE.					
Physical address: Corner River and Blaauwberg Streets, Ladanna, 0699.					
BIDDING PROCEDURE ENQUIRIES MAY BE DIRECTED TO					
CONTACT PERSON	Mr. NJ Motsopye				
TELEPHONE NUMBER	0152847126	E-MAIL ADDRESS	motsopyen@dpw.limpopo.gov.za		
CONTACT PERSON (TECHNICAL)	Mr. Vincent Maluleke				
TELEPHONE NUMBER	0152847219	E-MAIL ADDRESS	malulekev@dpw.limpopo.gov.za		
SUPPLIER INFORMATION					
NAME OF BIDDER					
POSTAL ADDRESS					
STREET ADDRESS					
TELEPHONE NUMBER	CODE		NUMBER		
CELLPHONE NUMBER					
E-MAIL ADDRESS					
VAT REGISTRATION NUMBER					
SUPPLIER COMPLIANCE STATUS	TAX COMPLIANCE SYSTEM PIN:		OR	CENTRAL SUPPLIER DATABASE No:	MAAA
<i>ARE YOU THE ACCREDITED REPRESENTATIVE IN SOUTH AFRICA FOR THE GOODS /SERVICES /WORKS OFFERED?</i>	<input type="checkbox"/> Yes <input type="checkbox"/> No [IF YES ENCLOSE PROOF]			<i>ARE YOU A FOREIGN BASED SUPPLIER FOR THE GOODS /SERVICES /WORKS OFFERED?</i>	<input type="checkbox"/> Yes <input type="checkbox"/> No [IF YES, ANSWER THE QUESTIONNAIRE BELOW]
QUESTIONNAIRE TO BIDDING FOREIGN SUPPLIERS					
IS THE ENTITY A RESIDENT OF THE REPUBLIC OF SOUTH AFRICA (RSA)?				<input type="checkbox"/> YES	<input type="checkbox"/> NO
DOES THE ENTITY HAVE A BRANCH IN THE RSA?				<input type="checkbox"/> YES	<input type="checkbox"/> NO
DOES THE ENTITY HAVE A PERMANENT ESTABLISHMENT IN THE RSA?				<input type="checkbox"/> YES	<input type="checkbox"/> NO
DOES THE ENTITY HAVE ANY SOURCE OF INCOME IN THE RSA?				<input type="checkbox"/> YES	<input type="checkbox"/> NO
IS THE ENTITY LIABLE IN THE RSA FOR ANY FORM OF TAXATION?				<input type="checkbox"/> YES	<input type="checkbox"/> NO
IF THE ANSWER IS "NO" TO ALL OF THE ABOVE, THEN IT IS NOT A REQUIREMENT TO REGISTER FOR A TAX COMPLIANCE STATUS SYSTEM PIN CODE FROM THE SOUTH AFRICAN REVENUE SERVICE (SARS) AND IF NOT REGISTER AS PER 2.3 BELOW.					

Bidder's initials

--

PART B: TERMS AND CONDITIONS FOR BIDDING

1. BID SUBMISSION:
1.1. BIDS MUST BE DELIVERED BY THE STIPULATED TIME TO THE CORRECT ADDRESS. LATE BIDS WILL NOT BE ACCEPTED FOR CONSIDERATION. 1.2. ALL BIDS MUST BE SUBMITTED ON THE OFFICIAL FORMS PROVIDED–(NOT TO BE RE-TYPED) OR IN THE MANNER PRESCRIBED IN THE BID DOCUMENT. 1.3. THIS BID IS SUBJECT TO THE PREFERENTIAL PROCUREMENT POLICY FRAMEWORK ACT, 2000 AND THE PREFERENTIAL PROCUREMENT REGULATIONS, 2017, THE GENERAL CONDITIONS OF CONTRACT (GCC) AND, IF APPLICABLE, ANY OTHER SPECIAL CONDITIONS OF CONTRACT. 1.4. THE SUCCESSFUL BIDDER WILL BE REQUIRED TO FILL IN AND SIGN A WRITTEN CONTRACT FORM (SBD7).
2. TAX COMPLIANCE REQUIREMENTS
2.1 BIDDERS MUST ENSURE COMPLIANCE WITH THEIR TAX OBLIGATIONS. 2.2 BIDDERS ARE REQUIRED TO SUBMIT THEIR UNIQUE PERSONAL IDENTIFICATION NUMBER (PIN) ISSUED BY SARS TO ENABLE THE ORGAN OF STATE TO VERIFY THE TAXPAYER'S PROFILE AND TAX STATUS. 2.3 APPLICATION FOR TAX COMPLIANCE STATUS (TCS) PIN MAY BE MADE VIA E-FILING THROUGH THE SARS WEBSITE WWW.SARS.GOV.ZA. 2.4 BIDDERS MAY ALSO SUBMIT A PRINTED TCS CERTIFICATE TOGETHER WITH THE BID. 2.5 IN BIDS WHERE CONSORTIA / JOINT VENTURES / SUB-CONTRACTORS ARE INVOLVED, EACH PARTY MUST SUBMIT A SEPARATE TCS CERTIFICATE / PIN / CSD NUMBER. 2.6 WHERE NO TCS PIN IS AVAILABLE BUT THE BIDDER IS REGISTERED ON THE CENTRAL SUPPLIER DATABASE (CSD), A CSD NUMBER MUST BE PROVIDED. 2.7 NO BIDS WILL BE CONSIDERED FROM PERSONS IN THE SERVICE OF THE STATE, COMPANIES WITH DIRECTORS WHO ARE PERSONS IN THE SERVICE OF THE STATE, OR CLOSE CORPORATIONS WITH MEMBERS PERSONS IN THE SERVICE OF THE STATE."

NB: FAILURE TO PROVIDE / OR COMPLY WITH ANY OF THE ABOVE PARTICULARS MAY RENDER THE BID INVALID.

SIGNATURE OF BIDDER:

CAPACITY UNDER WHICH THIS BID IS SIGNED:
 (Proof of authority must be submitted e.g. company resolution)

DATE:

Bidder's initials

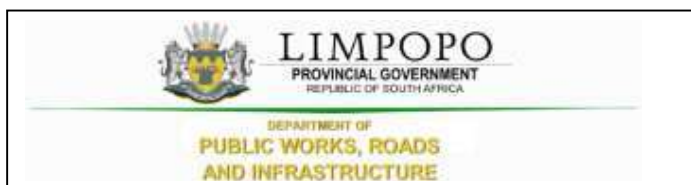

SBD 6.1

PREFERENCE POINTS CLAIM FORM IN TERMS OF THE PREFERENTIAL PROCUREMENT REGULATIONS 2022

This preference form must form part of all tenders invited. It contains general information and serves as a claim form for preference points for specific goals.

NB: BEFORE COMPLETING THIS FORM, TENDERERS MUST STUDY THE GENERAL CONDITIONS, DEFINITIONS AND DIRECTIVES APPLICABLE IN RESPECT OF THE TENDER AND PREFERENTIAL PROCUREMENT REGULATIONS, 2022

1. GENERAL CONDITIONS

- 1.1 The following preference point systems are applicable to invitations to tender:
- the 80/20 system for requirements with a Rand value of up to R50 000 000 (all applicable taxes included); and
 - the 90/10 system for requirements with a Rand value above R50 000 000 (all applicable taxes included).
- 1.2 **To be completed by the organ of state**
(delete whichever is not applicable for this tender).
- a) The applicable preference point system for this tender is the 90/10 preference point system.
 - b) The applicable preference point system for this tender is the 80/20 preference point system.
 - c) Either the 90/10 or 80/20 preference point system will be applicable in this tender. The lowest/ highest acceptable tender will be used to determine the accurate system once tenders are received.
- 1.3 Points for this tender (even in the case of a tender for income-generating contracts) shall be awarded for:
- (a) Price; and
 - (b) Specific Goals.

1.4 **To be completed by the organ of state:**

The maximum points for this tender are allocated as follows:

Bidder's initials

	POINTS
PRICE	80
SPECIFIC GOALS	20
Total points for Price and SPECIFIC GOALS	100

1.5 Failure on the part of a tenderer to submit proof or documentation required in terms of this tender to claim points for specific goals with the tender, will be interpreted to mean that preference points for specific goals are not claimed.

1.6 The organ of state reserves the right to require of a tenderer, either before a tender is adjudicated or at any time subsequently, to substantiate any claim in regard to preferences, in any manner required by the organ of state.

2. DEFINITIONS

- (a) “**tender**” means a written offer in the form determined by an organ of state in response to an invitation to provide goods or services through price quotations, competitive tendering process or any other method envisaged in legislation;
- (b) “**price**” means an amount of money tendered for goods or services, and includes all applicable taxes less all unconditional discounts;
- (c) “**rand value**” means the total estimated value of a contract in Rand, calculated at the time of bid invitation, and includes all applicable taxes;
- (d) “**tender for income-generating contracts**” means a written offer in the form determined by an organ of state in response to an invitation for the origination of income-generating contracts through any method envisaged in legislation that will result in a legal agreement between the organ of state and a third party that produces revenue for the organ of state, and includes, but is not limited to, leasing and disposal of assets and concession contracts, excluding direct sales and disposal of assets through public auctions; and
- (e) “**the Act**” means the Preferential Procurement Policy Framework Act, 2000 (Act No. 5 of 2000).
- (f)

3. FORMULAE FOR PROCUREMENT OF GOODS AND SERVICES

3.1. POINTS AWARDED FOR PRICE

3.1.1 THE 80/20 OR 90/10 PREFERENCE POINT SYSTEMS

A maximum of 80 or 90 points is allocated for price on the following basis:

$$Ps = 80 \left(1 - \frac{Pt - P_{min}}{P_{min}} \right) \quad \text{or} \quad Ps = 90 \left(1 - \frac{Pt - P_{min}}{P_{min}} \right)$$

Where

Bidder's initials

- Ps = Points scored for price of tender under consideration
Pt = Price of tender under consideration
Pmin = Price of lowest acceptable tender

3.2. FORMULAE FOR DISPOSAL OR LEASING OF STATE ASSETS AND INCOME GENERATING PROCUREMENT

3.2.1. POINTS AWARDED FOR PRICE

A maximum of 80 or 90 points is allocated for price on the following basis:

$$Ps = 80 \left(1 + \frac{Pt - P_{max}}{P_{max}} \right) \quad \text{or} \quad Ps = 90 \left(1 + \frac{Pt - P_{max}}{P_{max}} \right)$$

Where

- Ps = Points scored for price of tender under consideration
Pt = Price of tender under consideration
Pmax = Price of highest acceptable tender

4. POINTS AWARDED FOR SPECIFIC GOALS

- 4.1. In terms of Regulation 4(2); 5(2); 6(2) and 7(2) of the Preferential Procurement Regulations, preference points must be awarded for specific goals stated in the tender. For the purposes of this tender the tenderer will be allocated points based on the goals stated in table 1 below as may be supported by proof/ documentation stated in the conditions of this tender:
- 4.2. In cases where organs of state intend to use Regulation 3(2) of the Regulations, which states that, if it is unclear whether the 80/20 or 90/10 preference point system applies, an organ of state must, in the tender documents, stipulate in the case of—
- (a) an invitation for tender for income-generating contracts, that either the 80/20 or 90/10 preference point system will apply and that the highest acceptable tender will be used to determine the applicable preference point system; or
 - (b) any other invitation for tender, that either the 80/20 or 90/10 preference point system will apply and that the lowest acceptable tender will be used to determine the applicable preference point system,
- then the organ of state must indicate the points allocated for specific goals for both the 90/10 and 80/20 preference point system.

Bidder's initials

Table 1: Specific goals for the tender and points claimed are indicated per the table below.

(Note to organs of state: Where either the 90/10 or 80/20 preference point system is applicable, corresponding points must also be indicated as such.

Note to tenderers: The tenderer must indicate how they claim points for each preference point system.)

The specific goals allocated points in terms of this tender	Number of points allocated (90/10 system) (To be completed by the organ of state)	Number of points allocated (80/20 system) (To be completed by the organ of state)	Number of points claimed (90/10 system) (To be completed by the tenderer)	Number of points claimed (80/20 system) (To be completed by the tenderer)
Persons who had no franchise in national elections prior to 1983 and 1993 (Attach certified copy of South African ID as proof)	2	6		
Women (Attach Director's certified copy of South African ID as proof + company registration documents)	1	3		
Disabled persons (Attach letter from Health Professional as proof)	1	2		
Promotion of SMMEs (Attach financial statement as proof)	1	2		
Enterprises located in Limpopo Province (Attach proof of address / Lease agreement)	1	2		
Promotion of enterprises located in the relevant District (Attach proof of address / Lease agreement)	1	2		
Promotion of youth (Attach Director's	1	1		

Bidder's initials

certified copy of South African ID as proof)				
Promotion of enterprises located in rural areas (Attach letter from Traditional Council/ Chief/Ward Councilor if not Traditional Council)	2	2		

DECLARATION WITH REGARD TO COMPANY/FIRM

4.3. Name of company/firm.....

4.4. Company registration number:

4.5. TYPE OF COMPANY/ FIRM

- Partnership/Joint Venture / Consortium
- One-person business/sole propriety
- Close corporation
- Public Company
- Personal Liability Company
- (Pty) Limited
- Non-Profit Company
- State Owned Company

[TICK APPLICABLE BOX]

4.6. I, the undersigned, who is duly authorised to do so on behalf of the company/firm, certify that the points claimed, based on the specific goals as advised in the tender, qualifies the company/ firm for the preference(s) shown and I acknowledge that:

- i) The information furnished is true and correct;
- ii) The preference points claimed are in accordance with the General Conditions as indicated in paragraph 1 of this form;
- iii) In the event of a contract being awarded as a result of points claimed as shown in paragraphs 1.4 and 4.2, the contractor may be required to furnish documentary proof to the satisfaction of the organ of state that the claims are correct;
- iv) If the specific goals have been claimed or obtained on a fraudulent basis or any of the conditions of contract have not been fulfilled, the organ of state may, in addition to any other remedy it may have –
 - (a) disqualify the person from the tendering process;
 - (b) recover costs, losses or damages it has incurred or suffered as a result of that person’s conduct;
 - (c) cancel the contract and claim any damages which it has suffered as a result of having to make less favourable arrangements due to such cancellation;

Bidder's initials

- (d) recommend that the tenderer or contractor, its shareholders and directors, or only the shareholders and directors who acted on a fraudulent basis, be restricted from obtaining business from any organ of state for a period not exceeding 10 years, after the *audi alteram partem* (hear the other side) rule has been applied; and
- (e) forward the matter for criminal prosecution, if deemed necessary.

.....
SIGNATURE(S) OF TENDERER(S)

SURNAME AND NAME:

DATE:

ADDRESS:

.....

.....

.....

Bidder's initials



DECLARATION OF CURRENT PROJECTS

Current value refers to current value of projects for both General Building (GB) and Civil Engineering (CE).

Please list the current projects which your company is busy executing in the table below.

If no projects at the moment the tender must indicate/write on this table

Table 1 List of current projects executed by the bidder

1. Do you have the current projects being executed Yes/No?
2. If Yes, please indicate the details on the table below. Please note that it is compulsory to answer the question and if the answer is yes, complete the table. If the question not answered or the table not completed the points will not be allocated.

Project Description	Project Value	Start date	Planned end date	Client Name	Contact Person number

Bidder's initials

**CONSTRUCTION OF NEW MANKWENG TRADITIONAL COUNCIL OFFICES FOR THE LIMPOPO DEPARTMENT OF COOPERATIVE GOVERNANCE, HUMAN SETTLEMENTS AND TRADITIONAL AFFAIRS
 CONTRACT No. LDPWRI-B/20359**

Bidder's initials

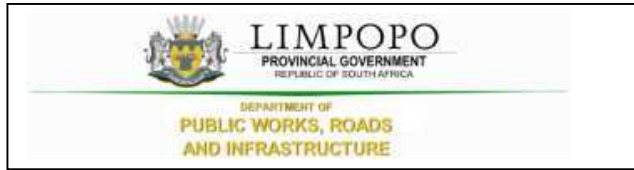

THE CONTRACT

Bidder's initials

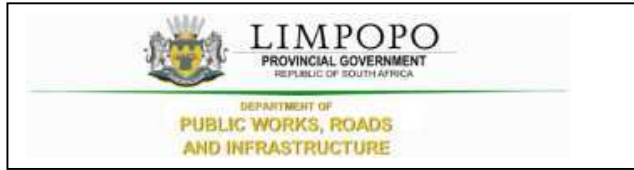

PART C1: AGREEMENT AND CONTRACT DATA

Bidder's initials

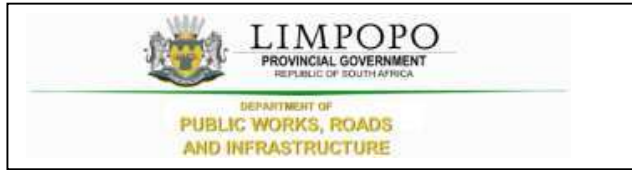

C1.1. FORM OF OFFER AND ACCEPTANCE

Offer

The employer, identified in the acceptance signature block, has solicited offers to enter into a contract in respect of the following works:

CONSTRUCTION OF NEW MANKWENG TRADITIONAL COUNCIL OFFICES AT CARPRICORN DISTRICT

The tenderer, identified in the offer signature block, has examined the documents listed in the tender data and addenda thereto as listed in the tender schedules, and by submitting this offer has accepted the conditions of tender.

By the representative of the tenderer, deemed to be duly authorized, signing this part of the Form of Offer and Acceptance, the tenderer offers to perform all of the obligations and liabilities of the contractor under the contract including compliance with all its terms and conditions according to their true intent and meaning for an amount to be determined in accordance with the conditions of contract identified in the contract data.

THE OFFERED TOTAL OF THE PRICE INCLUSIVE OF VALUE ADDED TAX IS (CONTRACT PRICE)

Rand (in words); R.....

.....

(in figures) R.....

This offer may be accepted by the employer by signing the acceptance part of this form of offer and acceptance and returning one copy of this document to the tenderer before the end of the period of validity stated in the tender data, whereupon the tenderer becomes the party named as the contractor in the conditions of contract identified in the contract data.

Signature(s)

Name(s)

Capacity

For the tenderer:

Name & signature of witness

Date

Bidder's initials

Acceptance (To be completed by the employer – not the bidder)

By signing this part of this Form of Offer and Acceptance, the *Employer* identified below accepts the tenderer's Offer. In consideration thereof, the *Employer* shall pay the Consultant the amount due in accordance with the *conditions of contract* identified in the Contract Data. Acceptance of the tenderer's Offer shall form an agreement between the *Employer* and the tenderer upon the terms and conditions contained in this agreement and in the contract that is the subject of this agreement.

The terms of the contract, are contained in:

- Part C1 Agreements and Contract Data, (which includes this Form of Offer and Acceptance)
- Part C2 Pricing Data
- Part C3 Scope of Work

and drawings and documents (or parts thereof), which may be incorporated by reference into the above listed Parts.

Deviations from and amendments to the documents listed in the Tender Data and any addenda thereto listed in the Returnable Schedules as well as any changes to the terms of the Offer agreed by the tenderer and the *Employer* during this process of offer and acceptance, are contained in the Schedule of Deviations attached to and forming part of this Form of Offer and Acceptance. No amendments to or deviations from said documents are valid unless contained in this Schedule.

The tenderer shall within two weeks of receiving a completed copy of this agreement, including the Schedule of Deviations (if any), contact the *Employer's* agent (whose details are given in the Contract Data) to arrange the delivery of any securities, bonds, guarantees, proof of insurance and any other documentation to be provided in terms of the *conditions of contract* identified in the Contract Data. Failure to fulfil any of these obligations in accordance with those terms shall constitute a repudiation of this agreement.

Notwithstanding anything contained herein, this agreement comes into effect on the date when the tenderer receives one fully completed original copy of this document, including the Schedule of Deviations (if any). Unless the tenderer (now *Consultant*) within five working days of the date of such receipt notifies the *Employer* in writing of any reason why he cannot accept the contents of this agreement, this agreement shall constitute a binding contract between the Parties.

For the Employer

Signature

Name

Capacity

Name and address of organization

Signature and Name of Witness

Signature

Name

Capacity

Bidder's initials

Schedule of Deviations

- 1 Subject
- Details
-
-
-

- 2 Subject
- Details
-
-
-

- 3 Subject
- Details
-
-
-

- 4 Subject
- Details
-
-
-

By the duly authorised representatives signing this agreement, the *Employer* and the Tenderer agree to and accept the foregoing schedule of deviations as the only deviations from and amendments to the documents listed in the Tender Data and addenda thereto as listed in the returnable schedules, as well as any confirmation, clarification or changes to the terms of the offer agreed by the Tenderer and the *Employer* during this process of offer and acceptance.

It is expressly agreed that no other matter whether in writing, oral communication or implied during the period between the issue of the tender documents and the receipt by the tenderer of a completed signed copy of this Agreement shall have any meaning or effect in the contract between the parties arising from this agreement.

.....

Bidder's initials

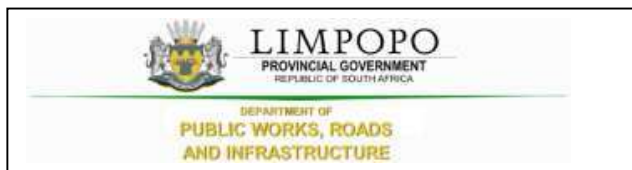

PART C2: PRICING DATA

C2.1 CONTRACT DATA

The Conditions of Contract are clauses 1 to 41 of the **JBCC Series 2000 Principal Building Agreement (Edition 4.1 of March 2005)** published by the Joint Building Contracts Committee.

Copies of these conditions of contract may be obtained from the Association of South African Quantity Surveyors (011-3154140), Master Builders Association (011-205-9000; 057- 3526269) South African Association of Consulting Engineers (011-4632022) or South African Institute of Architects (051-4474909; 011-4860684; 053-8312003;)

The JBCC Principal Building Agreement makes several references to the Contract Data for specific data, which together with these conditions collectively describe the risks, liabilities, and obligations of the contracting parties and the procedures for the administration of the Contract. The Contract Data shall have precedence in the interpretation of any ambiguity or inconsistency between it and the JBCC Principal Building Agreement.

The contractor shall achieve in the performance of the contract the Contract Participation Goals (CPG) relating to the engagement of targeted enterprises as established in the **CIDB Standard for Indirect Targeting for Enterprise Development through Construction Works Contracts Gazette Notice No. 36190 of 25 February 2013.**"

Bidder's initials

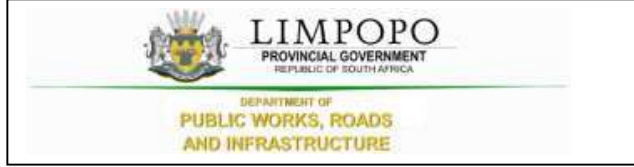

PART C2.2: BILLS OF QUANTITIES

Bidder's initials

Item No	Quantity	Rate	Amount
<u>SECTION No. 1 BILL No. 1</u>			
<u>PRELIMINARIES</u>			
i) The agreement is to be the JBCC Series 2000 Principal Building Agreement (Edition 4.1 Code 2101 March 2005) prepared by the Joint Building Contracts Committee			
ii) The preliminaries are to be the JBCC Series 2000 Preliminaries prepared by the Joint Building Contracts Committee, Code 2103 May 2005 Edition and shall be deemed to be incorporated herein			
iii) Tenderers are referred to the above mentioned documents for the full intent and meaning of each clause thereof (hereinafter referred to by heading and clause number only) for which such allowance must be made as may be considered necessary			
iv) Where standard clauses or alternatives are not entirely applicable to this contract such modifications, corrections or supplements as will apply are given under each relevant clause heading			
v) Where any item is not relevant to this specific contract such item is marked N/A (signifying "not applicable")			
vi) If Alternative A as set out in clause B10.3 hereinafter is to be used for the adjustment of the preliminaries each item priced is to be allocated to one or more of the three categories, where "F" denotes a fixed amount (amount not to be varied), "V" denotes an amount variable in proportion to value and "T" denotes an amount in proportion to time			
SECTION A: PRINCIPAL BUILDING AGREEMENT READ IN CONJUNCTION WITH THE CONTRACT DATA			
Carried to Collection			R
Section No. 1 Bill No. 1 Preliminaries CONSTRUCTION OF NEW MANKWENG TRADITIONAL COUNCIL OFFICE FOR COGHSTA			

Definitions (A1)

1	Definitions and interpretation (clause 1) Fixed	Item
2	Value Related	Item
3	Time Related	Item

Objective (A2)

4	Offer acceptance and performance (clause 2) Fixed	Item
5	Value Related	Item
6	Time Related	Item

Preparation (A3-A14)

7	Documents (clause 3) Fixed	Item
8	Value Related	Item
9	Time Related	Item
10	Design responsibility (clause 4) Fixed	Item
11	Value Related	Item
12	Time Related	Item
13	Employer's agents (clause 5) Fixed	Item
14	Value Related	Item
15	Time Related	Item
16	Site representative (clause 6) Fixed	Item
17	Value Related	Item

Carried to Collection

R

Section No. 1
Bill No. 1
Preliminaries

**CONSTRUCTION OF NEW MANKWENG TRADITIONAL COUNCIL OFFICE
FOR COGHSTA**

18	Time Related	Item
19	Compliance with regulations (clause 7) Fixed	Item
20	Value Related	Item
21	Time Related	Item
22	Works risk (clause 8) Fixed	Item
23	Value Related	Item
24	Time Related	Item
25	Indemnities (clause 9) Fixed	Item
26	Value Related	Item
27	Time Related	Item
28	Works insurance (clause 10) Fixed	Item
29	Value Related	Item
30	Time Related	Item
31	Liability insurances (clause 11) Fixed	Item
32	Value Related	Item
33	Time Related	Item
34	Effecting insurance (clause 12) Fixed	Item
35	Value Related	Item
36	Time Related	Item
37	No clause (clause 13) Fixed	Item
38	Value Related	Item
39	Time Related	Item

Carried to Collection

R

Section No. 1
 Bill No. 1
 Preliminaries

**CONSTRUCTION OF NEW MANKWENG TRADITIONAL COUNCIL OFFICE
 FOR COGHSTA**

40	Security (clause 14) Fixed		Item
41		Value Related	Item
42		Time Related	Item
<u>Execution (A15-A22)</u>			
43	Preparation for and execution of the works (clause 15) Fixed		Item
44		Value Related	Item
45		Time Related	Item
46	Access to the works (clause 16) Fixed		Item
47		Value Related	Item
48		Time Related	Item
49	Contract instructions (clause 17) Fixed		Item
50		Value Related	Item
51		Time Related	Item
52	Assignment (clause 19) Fixed		Item
53		Value Related	Item
54		Time Related	Item
55	Setting out of the works (clause 18) Fixed		Item
56		Value Related	Item
57		Time Related	Item

Carried to Collection

R

Section No. 1
 Bill No. 1
 Preliminaries

CONSTRUCTION OF NEW MANKWENG TRADITIONAL COUNCIL OFFICE FOR COGHSTA

The contractor shall notify the principal agent if any encroachments of adjoining foundations, buildings, structures, pavements, boundaries, etc. exist in order that the necessary arrangements may be made for the rectification of any such encroachments.

58	Nominated subcontractors (clause 20) Fixed	Item
59	Value Related	Item
60	Time Related	Item
61	Selected subcontractors (clause 21) Fixed	Item
62	Value Related	Item
63	Time Related	Item
64	Employer's Direct Contractors (clause 22) Fixed	Item
65	Value Related	Item
66	Time Related	Item
67	Contractor's Domestic Sub-Contractors (Clause 23) Fixed	Item
68	Value Related	Item
69	Time Related	Item
<u>Completion (A24-A30)</u>		
70	Practical completion (clause 24) Fixed	Item
71	Value Related	Item
72	Time Related	Item

Carried to Collection

R

Section No. 1
 Bill No. 1
 Preliminaries

CONSTRUCTION OF NEW MANKWENG TRADITIONAL COUNCIL OFFICE FOR COGHSTA

73	Works completion (clause 25) Fixed		Item	
74		Value Related	Item	
75		Time Related	Item	
76	Final completion (clause 26) Fixed		Item	
77		Value Related	Item	
78		Time Related	Item	
79	Latent defects liability period (clause 27) Fixed		Item	
80		Value Related	Item	
81		Time Related	Item	
82	Sectional completion (clause 28) Fixed		Item	
83		Value Related	Item	
84		Time Related	Item	
85	Revision of date of practical completion (clause 29) Fixed		Item	
86		Value Related	Item	
87		Time Related	Item	
88	Penalty for non-completion (clause 30) Fixed		Item	
89		Value Related	Item	
90		Time Related	Item	
Carried to Collection				
Section No. 1 Bill No. 1 Preliminaries CONSTRUCTION OF NEW MANKWENG TRADITIONAL COUNCIL OFFICE FOR COGHSTA				R

<u>Payment (A31 - A35)</u>			
91	Interim payment to the contractor (clause 31) Fixed	Item	
92	Value Related	Item	
93	Time Related	Item	
94	Adjustment to the contract value (clause 32) Fixed	Item	
95	Value Related	Item	
96	Time Related	Item	
Notwithstanding the provisions of clause 32.13 fluctuations in costs shall not be adjusted as per heyllet formular (CPA)			
97	Recovery of expense and loss (clause 33) Fixed	Item	
98	Value Related	Item	
99	Time Related	Item	
100	Final account and final payment (clause 34) Fixed	Item	
101	Value Related	Item	
102	Time Related	Item	
103	Payment to other parties (clause 35) Fixed	Item	
104	Value Related	Item	
105	Time Related	Item	
<u>Cancellation (A36-A39)</u>			
106	Cancellation by employer - contractor's default (clause 36) Fixed	Item	
107	Value Related	Item	
Carried to Collection			
Section No. 1			
Bill No. 1			
Preliminaries			
CONSTRUCTION OF NEW MANKWENG TRADITIONAL COUNCIL OFFICE FOR COGHSTA			
			R

108	Time Related	Item	
109	Cancellation by employer - loss and damage (clause 37) Fixed	Item	
110	Value Related	Item	
111	Time Related	Item	
112	Cancellation by contractor - employer's default (clause 38) Fixed	Item	
113	Value Related	Item	
114	Time Related	Item	
115	Cancellation - cessation of the works (clause 39) Fixed	Item	
116	Value Related	Item	
117	Time Related	Item	
	<u>Dispute (A40)</u>		
118	Settlement of disagreements and disputes (clause 40) Fixed	Item	
119	Value Related	Item	
120	Time Related	Item	
	<u>Contract variables (A41)</u>		
121	The schedule:Pre-tender information (clause 41) Fixed	Item	
122	Value Related	Item	
123	Time Related	Item	
	Carried to Collection		R
Section No. 1 Bill No. 1 Preliminaries CONSTRUCTION OF NEW MANKWENG TRADITIONAL COUNCIL OFFICE FOR COGHSTA			

Information necessary for completion of those clauses contained in the schedule which are necessary for tender purposes is given hereunder

41.1.1

Employer:

DEPARTMENT OF PUBLIC WORKS ROADS AND INFRASTRUCTURE LIMPOPO

Postal Address:
Private Bag x 9490
POLOKWANE
0700

Physical Address:
43 Church Street
Polokwane
0699

Tel . (015) 284-7000 Fax (015) 284 7044
E-mail :

41.1.2

Principal Agent:

DEPARTMENT OF PUBLIC WORKS ROADS AND INFRASTRUCTURE LIMPOPO

Postal Address:
Private Bag x 9490
POLOKWANE
0700

Physical Address:
43 Church Street
Polokwane
0699

Tel . (015) 284-7000 Fax (015) 284 7044
E-mail :

Carried to Collection

R

Section No. 1
Bill No. 1
Preliminaries

CONSTRUCTION OF NEW MANKWENG TRADITIONAL COUNCIL OFFICE FOR COGHSTA

41.1.3

Other Agents: Architect

DEPARTMENT OF PUBLIC WORKS ROADS AND INFRASTRUCTURE LIMPOPO

Postal Address:
Private Bag x 9490
POLOKWANE
0700

Physical Address:
43 Church Street
Polokwane
0699

Tel . (015) 284-7000 Fax (015) 284 7044
E-mail :

41.1.4

Other Agents : Quantity Surveyors

DEPARTMENT OF PUBLIC WORKS ROADS AND INFRASTRUCTURE LIMPOPO

Postal Address:
Private Bag x 9490
POLOKWANE
0700

Physical Address:
43 Church Street
Polokwane
0699

Tel . (015) 284-7000 Fax (015) 284 7044
E-mail :

Carried to Collection

R

Section No. 1
Bill No. 1
Preliminaries

CONSTRUCTION OF NEW MANKWENG TRADITIONAL COUNCIL OFFICE FOR COGHSTA

41.2 CONTRACT DETAILS

41.2.1 Works Description:

The work consist of the construction of a new single storey traditional council building approximately **550m2**, guardhouse approximately **30m2** and general site works

41.2.2 Site Description:

The site is at Manangeng Village

41.2.3 Work for installation by direct contractors:

N/A

41.2.4 This agreement is for a government contract: contract where there are specific option that are applicable to a state organ only

Yes

41.2.5 Date on which possession of the site is intended to be given:

Approximately within 14 (fourteen) calender days from the date of the letter of acceptance

41.2.6 Period for the commencement of the works is immediately after the contractor takes possession of the site

41.2.7 Completion in sections are required

No

Carried to Collection

R

Section No. 1
Bill No. 1
Preliminaries

CONSTRUCTION OF NEW MANKWENG TRADITIONAL COUNCIL OFFICE FOR COGHSTA

41.2.8 Intended date of practical completion and the penalty per calendar day for the works as a whole:
12 calendar months from the date of the possession of the site and penalties will be 0.05% of the contract sum

Penalty per calendar day:
 0.05% of the Contract Sum per calendar day on which the completion of the work may be in arrears

SPECIAL COMPLETION REQUIREMENTS

Not applicable

124 41.2.9 Arbitration rules as recommended by the Association of Arbitrators (SA) Fixed

Item

125 Value Related

Item

126 Time Related

Item

127 41.2.10 The law applicable to this agreement shall be that of

South Africa Fixed

Item

128 Value Related

Item

129 Time Related

Item

Carried to Collection

R

Section No. 1
 Bill No. 1
 Preliminaries

CONSTRUCTION OF NEW MANKWENG TRADITIONAL COUNCIL OFFICE FOR COGHSTA

41.3 INSURANCES		
130	<p>41.3.1 Contract work's insurance</p> <p>All risk and Public Liability Insurance for this contract shall be taken out by the Contractor in the joint names of the contractor and the employer. The cost of this insurance will be paid by the Contractor. Any excess in respect of a claim is to be paid for by the contractor</p>	Item
131	<p>41.3.2 Supplementary insurance:</p> <p>Contractor shall be responsible for the taking out his own insurances for all plant and machinery used in the execution of this contract. The cost of this insurance shall be borne by the contractor. Fixed</p>	Item
132	Value Related	Item
133	Time Related	Item
134	<p>41.3.3 Public liability insurance to be effected by contractor</p> <p>See clause 42.3.1 Fixed</p>	Item
135	Value Related	Item
136	Time Related	Item
41.4 DOCUMENTS		
	<p>41.4.1 Waivers of contractors lien is required</p> <p style="text-align: right;">Yes</p>	
	<p>41.4.2 Number of construction document copies to be supplied free of charge: Three</p>	
Carried to Collection		
<p>Section No. 1 Bill No. 1 Preliminaries CONSTRUCTION OF NEW MANKWENG TRADITIONAL COUNCIL OFFICE FOR COGHSTA</p>		
		R

41.4.3 State other system if document is not drawn up in accordance with the Standard System of Measuring Building Work (6th Edition) (Revised) 1999

41.4.4 Number of days for submission of priced documents:
7 working days

Notwithstanding the provisions of Clause 41.4.4, no payments will be certified unless the priced document are agreed with the Quantity surveyors.

41.4.5 JBCC N/S Subcontract Agreement are to be included in the documents: No

41.4.6 Alternative if contract value is not adjusted using CPAP:

Prices and rates shall remain firm and fixed, there shall be no adjustment of the tender amounts

41.4.7 Details of changes made to the provision of JBCC standard documentation:

Payment will be made 21 days after issue of a payment certificate.

The Contractor shall issue a Tax Invoice immediately to enable the Employer to process payment. For accounting purposes, the Employer's VAT number as required by current legislation on the Tax invoice is **to be advised**

SECTION B: PRELIMINARIES

Definition and interpretation (B1)

137	Definition and interpretation (B1.1 - B1.6.5) Fixed	Item
138	Value Related	Item
139	Time Related	Item

Carried to Collection

R

Section No. 1
Bill No. 1
Preliminaries

CONSTRUCTION OF NEW MANKWENG TRADITIONAL COUNCIL OFFICE FOR COGHSTA

<u>Documents (B2)</u>			
140	Checking of documents (B2.1) Fixed	Item	
141	Value Related	Item	
142	Time Related	Item	
143	These bills of quantities contain pages and annexures as indexed on the flyleaf The items in these bills of quantities are to be read and priced in conjunction with and the descriptions regarded as amplified by the Model Preambles for Trades as recommended and published by the Association of South African Quantity Surveyors, 2008 edition, and no claim arising from brevity of description of items fully described in the said Model Preambles for Trades will be entertained	Item	
144	Provisional bills of quantities (B2.2) Fixed	N/A	
145	Value Related	Item	
146	Time Related	Item	
147	Availability of construction documentation for contracts based on provisional bills of quantities (B2.3) Fixed	Item	
148	Value Related	Item	
149	Time Related	Item	
150	Interests of agents (B2.4) Fixed	Item	
151	Value Related	Item	
152	Time Related	Item	
153	Priced documents (B2.5) Fixed	Item	
154	Value Related	Item	
155	Time Related	Item	
Carried to Collection			
Section No. 1 Bill No. 1 Preliminaries CONSTRUCTION OF NEW MANKWENG TRADITIONAL COUNCIL OFFICE FOR COGHSTA			R

156	Tender submission (B2.6) Fixed	Item	
157	Value Related	Item	
158	Time Related	Item	
159	Notwithstanding anything contained in this clause tenders shall be valid for a period of 45 days from the closing date of tenders Fixed	Item	
160	Value Related	Item	
161	Time Related	Item	
	<u>The site (B3)</u>		
162	Defined works area (B3.1) Fixed	Item	
163	Value Related	Item	
164	Time Related	Item	
165	The area of the works to be occupied by the contractor, any restriction on the area and the limit of access or exit will be pointed out to the contractor by the principal agent at the official site briefing meeting.	Item	
166	Geotechnical investigation (B3.2) Geotechnical information will be made available to the successful bidder at the site handover meeting Fixed	Item	
167	Value Related	Item	
168	Time Related	Item	
	Carried to Collection		R
	Section No. 1 Bill No. 1 Preliminaries CONSTRUCTION OF NEW MANKWENG TRADITIONAL COUNCIL OFFICE FOR COGHSTA		

169	Inspection of the site (B3.3) It remains the responsibility of the bidder to visit the project site on his / her own to check and acquaint themselves with the site and its conditions before submitting a tender as no claims will be entertained later.					
170	No claims for extras arising from the contractor having failed to comply with this clause will be entertained Fixed			Item		
171		Value Related		Item		
172		Time Related		Item		
173	Existing premises occupied (B3.4) Fixed			Item		
174		Value Related		Item		
175		Time Related		Item		
176	Previous work - dimensional accuracy (B3.5) Fixed			Item		
177		Value Related		Item		
178		Time Related		Item		
179	Previous work - defects (B3.6) Fixed			Item		
180		Value Related		Item		
181		Time Related		Item		
182	Services - known (B3.7) Fixed			Item		
183		Value Related		Item		
184		Time Related		Item		
185	Services - unknown (B3.8) Fixed			Item		
		Carried to Collection				
	Section No. 1 Bill No. 1 Preliminaries CONSTRUCTION OF NEW MANKWENG TRADITIONAL COUNCIL OFFICE FOR COGHSTA					R

186		Value Related	Item	
187		Time Related	Item	
188	Protection of trees etc (B3.9) Fixed		Item	
189		Value Related	Item	
190		Time Related	Item	
191	Articles of value (B3.10) Fixed		Item	
192		Value Related	Item	
193		Time Related	Item	
194	Inspection of adjoining properties etc (B3.11) Fixed		Item	
195		Value Related	Item	
196		Time Related	Item	
	<u>Management of contract (B4)</u>			
197	Management of the works (B4.1) Fixed		Item	
198		Value Related	Item	
199		Time Related	Item	
200	Progress meetings (B4.3) Fixed		Item	
201		Value Related	Item	
202		Time Related	Item	
203	Technical meetings (B4.4) Fixed		Item	
204		Value Related	Item	
205		Time Related	Item	
	<u>Samples and shop drawings and manufacturer's instructions (B5)</u>			
206	Samples of materials (B5.1) Fixed		Item	
	Carried to Collection			
	Section No. 1			
	Bill No. 1			
	Preliminaries			
	CONSTRUCTION OF NEW MANKWENG TRADITIONAL COUNCIL OFFICE FOR COGHSTA			R

207		Value Related	Item	
208		Time Related	Item	
209	Workmanship samples (B5.2) Fixed		Item	
210		Value Related	Item	
211		Time Related	Item	
212	Shop drawings (B5.3) Fixed		Item	
213		Value Related	Item	
214		Time Related	Item	
	<u>Temporary works and plant (B6)</u>			
215	Deposits and fees (B6.1) Fixed		Item	
216		Value Related	Item	
217		Time Related	Item	
218	Enclosure of the works (B6.2) Fixed		Item	
219		Value Related	Item	
220		Time Related	Item	
221	Advertising (B6.3) Fixed		Item	
222		Value Related	Item	
223		Time Related	Item	
224	Plant, equipment, sheds and offices (B6.4) Fixed		Item	
225		Value Related	Item	
226		Time Related	Item	
227	Main notice board (B6.5) Fixed		Item	
	Carried to Collection			
	Section No. 1 Bill No. 1 Preliminaries CONSTRUCTION OF NEW MANKWENG TRADITIONAL COUNCIL OFFICE FOR COGHSTA			R

228		Value Related	Item	
229		Time Related	Item	
230	Subcontractors notice board (B6.6) Fixed		Item	
231		Value Related	Item	
232		Time Related	Item	
	<u>Temporary services (B7)</u>			
233	Location (B7.1) Fixed		Item	
234		Value Related	Item	
235		Time Related	Item	
236	Water (B7.2) Fixed		Item	
237		Value Related	Item	
238		Time Related	Item	
239	Electricity (B7.3) Fixed		Item	
240		Value Related	Item	
241		Time Related	Item	
242	Telecommunication equipment (B7.4) Fixed		Item	
243		Value Related	Item	
244		Time Related	Item	
245	Ablution facilities (B7.5) Fixed		Item	
246		Value Related	Item	
247		Time Related	Item	
	<u>Prime cost amounts (B8)</u>			
248	Responsibility for prime cost amounts (B8.1) Fixed		Item	
	Carried to Collection			
	Section No. 1			
	Bill No. 1			
	Preliminaries			
	CONSTRUCTION OF NEW MANKWENG TRADITIONAL COUNCIL OFFICE FOR COGHSTA			

R

249	Value Related	Item	
250	Time Related	Item	
<u>Attendance on N/S Subcontractors (B9)</u>			
251	General attendance (B9.1) Fixed	Item	
252	Value Related	Item	
253	Time Related	Item	
254	Special attendance (B9.2) Fixed	Item	
255	Value Related	Item	
256	Time Related	Item	
257	Commissioning - Fuel, water and power (B9.3) Fixed	Item	
258	Value Related	Item	
259	Time Related	Item	
<u>Financial aspects (B10)</u>			
260	Statutory taxes, duties and levies (B10.1) Fixed	Item	
261	Value Related	Item	
262	Time Related	Item	
263	Provision for Value Added Tax (VAT) is made in the Final Summary. Fixed	Item	
264	Value Related	Item	
265	Time Related	Item	
266	Payment of preliminaries (B10.2) Fixed	Item	
267	Value Related	Item	
268	Time Related	Item	
Carried to Collection			R
Section No. 1 Bill No. 1 Preliminaries CONSTRUCTION OF NEW MANKWENG TRADITIONAL COUNCIL OFFICE FOR COGHSTA			

269	Adjustment of preliminaries (B10.3) Fixed	Item
270	Value Related	Item
271	Time Related	Item
272	Payment certificate cash flow (B10.4) Fixed	Item
273	Value Related	Item
274	Time Related	Item
275	Contractor information supply (B10.5) Fixed	Item
276	Value Related	Item
277	Time Related	Item
<u>General (B11)</u>		
278	Protection of works (B11.1) Fixed	Item
279	Value Related	Item
280	Time Related	Item
281	Protection/isolation of existing/sectionally occupied works (B11.2) Fixed	Item
282	Value Related	Item
283	Time Related	Item
284	Site security (B11.3) Fixed	Item
285	Value Related	Item
286	Time Related	Item
287	Notice before covering work (B11.4) Fixed	Item
288	Value Related	Item
289	Time Related	Item

Carried to Collection

R

Section No. 1
 Bill No. 1
 Preliminaries

CONSTRUCTION OF NEW MANKWENG TRADITIONAL COUNCIL OFFICE FOR COGHSTA

290	Disturbance (B11.5) Fixed		Item
291		Value Related	Item
292		Time Related	Item
293	Works cleaning and clearing (B11.6) Fixed		Item
294		Value Related	Item
295		Time Related	Item
296	Vermin (B11.7) Fixed		Item
297		Value Related	Item
298		Time Related	Item
299	Overhand work (B11.8) Fixed		Item
300		Value Related	Item
301		Time Related	Item

Schedule of variables (B12)

302	Pre-tender information (B12.1) Fixed		Item
303		Value Related	Item
304		Time Related	Item

Information necessary for elections and completion of those clauses contained in the schedule which are necessary for tender purposes is given hereunder. Where no information is given it shall mean that either no details or specific requirements are available or that the clause is not relevant to this specific contract

Carried to Collection

R

Section No. 1
 Bill No. 1
 Preliminaries

CONSTRUCTION OF NEW MANKWENG TRADITIONAL COUNCIL OFFICE FOR COGHSTA

<p>12.1.1 Provisional bills of quantities (B2.2) The quantities are provisional:</p> <p style="text-align: right;">Yes</p>			
<p>12.1.2 Availability of construction documentation (B2.3) Construction documentation is complete</p> <p style="text-align: right;">Yes</p>			
<p>12.1.3 Interest of agents (B2.4) N/A</p>			
<p>12.1.4 Defined works area (B3.1) See site information</p>			
<p>12.1.5 Geotechnical investigation (B3.2) To obtain from the Project Geotechnical Specialist Geotechnical information will be made available to the successful bidder at the site handover meeting</p>			
<p>12.1.6 Existing premises occupied (B3.4)</p>			
<p>12.1.7 Services - known (B3.7) Existing services and points of connection will be pointed out to the successful contractor by the principal agent</p>			
<p>12.1.8 Protection of trees (B3.9)</p>			
<p>12.1.9 Inspection of adjoining properties (B3.11)</p>			
<p>12.1.10 Enclosure of the works (B6.2)</p>			
<p>Carried to Collection</p> <p>Section No. 1 Bill No. 1 Preliminaries CONSTRUCTION OF NEW MANKWENG TRADITIONAL COUNCIL OFFICE FOR COGHSTA</p>		<p>R</p>	

12.1.11 Offices (B6.4.3)

The contractor shall provide, maintain and remove on completion of the work an office minimum size 4 x 6 x 3m high internally, suitably insulated and ventilated, provided with electric lighting and fitted with boarded floor, desk, chair, and lockup drawer for drawings. The office shall be kept clean and fit for use at all times

12.1.12 Main notice board (B6.5)

The contractor shall provide, erect where directed, maintain and remove on completion of the works a notice board size 3 x 3m, all constructed of suitable boarding with flat smooth surface and with edging bead 19mm thick all round outer edges and projecting 12mm from face of boarding and rounded on front edge. The board shall be securely fixed to hoarding, where hoarding is provided, or fixed to and including a suitable supporting structure of timber or tubular posts and braces. The board is to be painted ivory white and the bead and and 12mm wide dividing lines, deep blue. All wording shall be inscribed in deep blue painted "sans serif" lettering

12.1.13 Subcontractors notice board (B6.6)

A notice board is required

No

12.1.14 Water (B7.2)

Contractor to provide

12.1.15 Electricity (B7.3)

Contractor to provide

12.1.16 Telecommunications (B7.4)

Contractor to provide

12.1.17 Ablution facilities (B7.5)

Contractor to provide

12.1.18 Special attendance (B9.2)

Carried to Collection

R

Section No. 1
 Bill No. 1
 Preliminaries

CONSTRUCTION OF NEW MANKWENG TRADITIONAL COUNCIL OFFICE FOR COGHSTA

	12.1.19 Protection of the works (B11.1)			
	12.1.20 Protection of existing/sectionally occupied works (B11.2) Protection is required	Yes		
	12.1.21 Disturbance (B11.5) The contractor's attention is drawn to the fact that certain portions of the Works will be constructed in the vicinity of built up areas, The contractor shall exercise all necessary precautions to ensure the safety and convenience of the public.			
305	Post tender information (B12.2) Fixed		Item	
306		Value Related	Item	
307		Time Related	Item	
	12.2.1 Payment of preliminaries Alternative selected: (B)			
	12.2.2 Adjustment of preliminaries Alternative selected: (A)			
	12.2.3 Additional agreed preliminaries item N/A			
	<u>SECTION C: SPECIFIC PRELIMINARIES</u>			
308	PROPRIETARY BRANDED PRODUCTS The contractor shall take delivery of, handle, store, use apply and/or fix all proprietary branded products in strict accordance with the manufacturers' instruction after consultation with the manufacturer's authorized representative Fixed		Item	
		Carried to Collection		R
	Section No. 1 Bill No. 1 Preliminaries CONSTRUCTION OF NEW MANKWENG TRADITIONAL COUNCIL OFFICE FOR COGHSTA			

309	Value Related	Item	
310	Time Related	Item	
311	OVERTIME		
	Should overtime be required to be worked for any reason whatsoever, the costs of such overtime are to be borne by the contractor unless the principal agent has specifically authorized in writing, prior to the execution thereof, that costs for such overtime are to be borne by the employer. Fixed	Item	
312	Value Related	Item	
313	Time Related	Item	
314	AS BUILT DRAWINGS		
	The position of construction breaks and the extent of individual concrete pours are to be recorded by the contractor on the structural engineer's drawings and are to be submitted to the principal agent and the structural engineer for their records. Fixed	Item	
315	Value Related	Item	
316	Time Related	Item	
317	SITE INSTRUCTIONS		
	Site instructions issued on site are to be recorded in triplicate in a site instruction book which is to be maintained on site by the contractor Fixed	Item	
318	Value Related	Item	
319	Time Related	Item	
	Carried to Collection		R
	Section No. 1 Bill No. 1 Preliminaries CONSTRUCTION OF NEW MANKWENG TRADITIONAL COUNCIL OFFICE FOR COGHSTA		

320	LABOUR RECORD		
	At the end of each week the contractor shall provide the principal agent with a written record, in schedule form, reflecting the number and description of tradesmen and labourers employed by him and all subcontractors on the works each day. Fixed		Item
321		Value Related	Item
322		Time Related	Item
323	PLANT RECORD		
	At the end of each week the contractor shall provide the principal agent with a written record, in schedule form, reflecting the number, type and capacity of all plant, excluding hand tools, currently used on the works. Fixed		Item
324		Value Related	Item
325		Time Related	Item
326	NON CESSION OF MONIES		
	The contractor shall not cede nor assign his rights or claims to any monies due or to become due under this contract Fixed		Item
327		Value Related	Item
328		Time Related	Item
329	BLACK ECONOMIC EMPOWERMENT		
	The contractor shall study and acquaint himself with the guidelines of the Black Economic Empowerment Act, and demonstrate his compliance with the requirements of the Act. Fixed		Item
330		Value Related	Item
331		Time Related	Item

Carried to Collection

R

Section No. 1
 Bill No. 1
 Preliminaries

CONSTRUCTION OF NEW MANKWENG TRADITIONAL COUNCIL OFFICE FOR COGHSTA

332	LOCAL LABOUR		
	The contractor shall make use of local labour. It is desirable by the Employer that all unskilled labour be recruited from the local areas of the vicinity of the Works. The contractor will demonstrate his effort to fulfill compliance with this requirement Fixed		Item
333		Value Related	Item
334		Time Related	Item
335	LABOUR DESK		
	The contractor shall establish a labour desk on site with a dedicated office of maximum 9m2 with and including a desk, 2 chairs and electricity. From the labour desk, the contractor will appoint a dedicated community liaison officer. The community liaison officer will be employed by and will report to the contractor, who will in turn forward such reports to the Principal Agent. Fixed		Item
336		Value Related	Item
337		Time Related	Item
338	SITE ACCOMMODATION STORAGE		
	Provide an office facilities for Principal Agent Representative (to include desk, 2chairs and Electricity per office) Provide meeting Facility to accommodate 12 chairs Provide Ablution facilities for the above Fixed		Item
339		Value Related	Item
340		Time Related	Item
341	HEALTH AND SAFETY ACT (Act 85 of 1993)		
	Compliance with the Occupational Health and Safety Act (Act 85 of 1993) and all relevant and applicable regulations, especially the Construction Health & Safety Act (Act 85 of 1993) (as amended) for the duration of the contract Fixed		Item
342		Value Related	Item

Carried to Collection

R

Section No. 1
Bill No. 1
Preliminaries

CONSTRUCTION OF NEW MANKWENG TRADITIONAL COUNCIL OFFICE FOR COGHSTA

343	Time Related	Item	
344	Provisions of OH&S Plan prior to commencement of works as well as a full consolidated copy of such plan at the completion of construction work inclusive of a record of all drawings, designs, copies of statutory appointments, material used and other similar information concerning completed contract	Item	
345	Implementation of approved OHS Plan for duration of contract, including daily/weekly inspections, monthly meetings, required audits, consolidated health and safety file, etc	Item	
346	Registration with Compensation Fund or approved /licensed compensation insurer	Item	
347	Full time competent employee of the Contractor as safety construction supervisor and assistant safety construction supervisors for duration of contract	Item	
348	Health and safety training and induction requirements of all persons entering the site	Item	
349	HIV AND AIDS POLICY Observation of all legislation, policies and by-laws regulating the "AIDS" endemic and "HIV" prevention, treatment and observation	Item	
	<u>Provision of Training Allowance in terms of EPWP prescripts</u>		
350	Training allowance paid to targeted labour in terms of formal training days	PDT	
351	Extra over for the administration payment of training allowances to targeted labour (25% of training allowance)	Item	10 000.00
352	Transport and accommodation of workers for training where it is not possible to undertake the training in close proximity to the site (Provisional Sum)	Item	1 000.00
	Carried to Collection		
	Section No. 1 Bill No. 1 Preliminaries CONSTRUCTION OF NEW MANKWENG TRADITIONAL COUNCIL OFFICE FOR COGHSTA		R

Section No. 1

Bill No. 1

Preliminaries

COLLECTION

Total Brought Forward from Page No.

**Page
No**

Amount

- 1
- 2
- 3
- 4
- 5
- 6
- 7
- 8
- 9
- 10
- 11
- 12
- 13
- 14
- 15
- 16
- 17
- 18
- 19
- 20

Carried Forward

R

Section No. 1

Bill No. 1

Preliminaries

**CONSTRUCTION OF NEW MANKWENG TRADITIONAL COUNCIL OFFICE
FOR COGHSTA**

Section No. 1

Bill No. 1

Preliminaries

COLLECTION

**Page
No**

Amount

Brought Forward

R

Total Brought Forward from Page No.

- 21
- 22
- 23
- 24
- 25
- 26
- 27
- 28
- 29
- 30

Carried to Final Summary

R

Section No. 1

Bill No. 1

Preliminaries

**CONSTRUCTION OF NEW MANKWENG TRADITIONAL COUNCIL OFFICE
FOR COGHSTA**

Item No		Quantity	Rate	Amount
	<u>SECTION No. 2BILL No. 1</u>			
	<u>EARTHWORKS (PROVISIONAL)</u>			
	<u>PREAMBLES</u>			
	For Preambles see "Model Preambles For Trades"			
	<u>EXCAVATION, FILLING, ETC OTHER THAN BULK</u>			
	<u>SITE CLEARANCE</u>			
	<u>Site Clearance, etc</u>			
1	Digging up and removing rubbish, debris and trees n.e 200mm girth, bush,etc	m2	2 638	
	<u>Excavation in earth not exceeding 2m deep</u>			
2	Trenches	m3	254	
3	Holes	m3	6	
	<u>Extra over bulk excavation in earth for excavation in</u>			
4	Soft rock	m3	25	
5	Hard rock	m3	27	
	<u>Extra over all excavations for carting away</u>			
6	Surplus material from excavations and/or stock piles on site to a dumping site to be located by the contractor	m3	116	
	<u>Risk of collapse of excavations</u>			
7	Sides of excavations not exceeding 1,5m deep	m2	757	
	<u>Keeping excavations free of water</u>			
8	Keeping excavations free of water	Item		
	Carried to Collection			R
	Section No. 2 Bill No. 1 Earthworks (Provisional) CONSTRUCTION OF NEW MANKWENG TRADITIONAL COUNCIL OFFICE FOR COGHSTA			

<u>Earth filling obtained from the excavations and/or prescribed stock piles on site compacted to 93% Mod AASHTO density</u>				
9	As backfilling to foundations	m3	127	
10	Under floors, steps, pavings, etc	m3	117	
<u>Earth filling supplied by the contractor compacted to 93% Mod AASHTO density</u>				
11	Under floors, steps, pavings, etc	m3	167	
<u>Compaction of surfaces</u>				
12	Compaction of ground surface under floors etc including scarifying for a depth of 100mm, breaking down oversize material, adding suitable material where necessary and compacting to 93% Mod AASHTO density	m2	650	
<u>Prescribed density tests on filling</u>				
13	"Modified AASHTO Density" test	No	16	
<u>PROTECTION AGAINST TERMITES</u>				
<u>Soil insecticide</u>				
14	Poisoning surface of ground in bottoms of trenches, bases, etc	m2	1 014	
15	Poisoning surface of ground or filling under floors, steps, etc. including raking out 75mm deep V-shaped channels against the walls, etc., treated with poison solution, backfilling and ramming	m2	650	
<u>BUDGETARY ALLOWANCES</u>				
16	Provide the sum of R 350 000-00 (Three hundred and Fifty thousand Rand) for unforeseen foundation conditions- Main Building and Gatehouse	Item		350 000.00
Carried to Collection				
Section No. 2				
Bill No. 1				
Earthworks (Provisional)				
CONSTRUCTION OF NEW MANKWENG TRADITIONAL COUNCIL OFFICE FOR COGHSTA				
				R

Section No. 2

Bill No. 1

Earthworks (Provisional)

COLLECTION

Total Brought Forward from Page No.

**Page
No**

33

34

Amount

Carried Forward to Summary of Section No. 2

R

Section No. 2

Bill No. 1

Earthworks (Provisional)

**CONSTRUCTION OF NEW MANKWENG TRADITIONAL COUNCIL OFFICE
FOR COGHSTA**

Item No		Quantity	Rate	Amount
	<u>SECTION No. 2BILL No. 2</u>			
	<u>CONCRETE, FORMWORK AND REINFORCEMENT</u>			
	<u>PREAMBLES</u>			
	For Preambles see "Model Preambles For Trades"			
	<u>UNREINFORCED CONCRETE CAST AGAINST EXCAVATED SURFACES</u>			
	<u>15Mpa/19mm Concrete</u>			
1	Surface blinding under footings and bases	m3	13	
2	Apron	m3	19	
	<u>REINFORCED CONCRETE CAST AGAINST EXCAVATED SURFACES</u>			
	<u>30 MPa/19mm Concrete</u>			
3	Strip footings	m3	58	
4	Base	m3	3	
	<u>REINFORCED CONCRETE</u>			
	<u>30 MPa/19mm Concrete</u>			
5	Slab	m3	1	
6	Surface beds	m3	60	
7	Columns	m3	6	
	<u>25 MPa/19mm Concrete</u>			
8	Ring beam	m3	8	
	Carried to Collection			R
	Section No. 2 Bill No. 2 Concrete, Formwork & Reinforcement CONSTRUCTION OF NEW MANKWENG TRADITIONAL COUNCIL OFFICE FOR COGHSTA			

TEST BLOCKS

9	Making and testing a set of three 150 x 150 x 150mm concrete strength test cube (Provisional)	No	24
---	---	----	----

Finishing top surfaces of concrete smooth with a wood float

10	Surface beds, slabs, etc	m2	822
----	--------------------------	----	-----

SMOOTH FORMWORK (DEGREE OF ACCURACY II)

Smooth formwork to sides

11	Edges, risers, ends and reveals not exceeding 300mm high or wide	m	346
----	--	---	-----

12	Edges, risers, ends and reveals, exceeding 300mm high or wide	m	14
----	---	---	----

13	Columns propped up exceeding 1,50m and not exceeding 3,50m high	m2	44
----	---	----	----

Smooth formwork to soffits

14	Slabs propped up exceeding 1,50m and not exceeding 3,50m high	m2	11
----	---	----	----

REINFORCEMENT

Mild steel reinforcement to structural concrete work

15	Steel bar reinforcement of various diameters (100kg/m3)	t	8.24
----	---	---	------

Fabric reinforcement

16	Ref 395 mesh steel reinforcement in foundation, etc	m2	1
----	---	----	---

17	Ref 395 mesh steel reinforcement in surface beds, etc	m2	651
----	---	----	-----

Carried to Collection

R

Section No. 2

Bill No. 2

Concrete, Formwork & Reinforcement

CONSTRUCTION OF NEW MANKWENG TRADITIONAL COUNCIL OFFICE FOR COGHSTA

Section No. 2

Bill No. 2

Concrete, Formwork & Reinforcement

COLLECTION

Total Brought Forward from Page No.

**Page
No**

36

37

Amount

Carried Forward to Summary of Section No. 2

Section No. 2

Bill No. 2

Concrete, Formwork & Reinforcement

**CONSTRUCTION OF NEW MANKWENG TRADITIONAL COUNCIL OFFICE
FOR COGHSTA**

R

Item No	Quantity	Rate	Amount
<u>SECTION No. 2BILL No. 3</u>			
<u>MASONRY</u>			
<u>PREAMBLES</u>			
For Preambles see "Model Preambles For Trades"			
<u>SUPPLEMENTARY PREAMBLES</u>			
<u>BRICKWORK</u>			
<u>Sizes in descriptions</u>			
Where sizes in descriptions are given in brick units, "one brick" shall represent the length and "half brick" the width of a brick			
<u>Face bricks</u>			
Bricks shall be ordered timeously to obtain uniformity in size and colour			
<u>Pointing</u>			
Descriptions of recessed pointing to fair face brickwork and face brickwork shall be deemed to include square recessed, hollow recessed, weathered pointing, etc			
<u>FOUNDATIONS</u>			
<u>Brickwork of NFXE bricks (14 MPa nominal compressive strength) in class I mortar in loadbearing walls etc</u>			
1	Brick piers	m3	1
2	Half brick wall	m2	105
3	One brick walls	m2	322
Carried to Collection			R
Section No. 2 Bill No. 3 Masonry CONSTRUCTION OF NEW MANKWENG TRADITIONAL COUNCIL OFFICE FOR COGHSTA			

	<u>Brickwork reinforcement</u>		
4	75mm Wide reinforcement built in horizontally	m	615
5	150mm Wide reinforcement built in horizontally	m	1 876
	<u>SUPERSTRUCTURE</u>		
	<u>Brickwork of NFXE bricks (14 MPa nominal compressive strength) in class I mortar in loadbearing walls etc</u>		
6	Brick piers	m3	3
7	Half brick walls	m2	208
8	Half brick wall in beamfilling	m2	41
9	One brick walls	m2	706
	<u>BRICKWORK SUNDRIES</u>		
	<u>Galvanised hoop iron cramps, ties, etc</u>		
10	30 x 1,6mm Roof tie 1,5m long with one end fixed to timber and other end built into brickwork	No	172
	<u>Brickwork reinforcement</u>		
11	75mm Wide reinforcement	m	906
12	150mm Wide reinforcement	m	2 035
	<u>Prestressed precast concrete fabricated lintels</u>		
13	110 x 75mm Lintels in lengths exceeding 3m	m	90
	<u>Turning pieces to lintels etc</u>		
14	110mm Wide turning pieces	m	143
	<u>FIBRE-CEMENT WINDOW SILLS</u>		
	Carried to Collection		
	Section No. 2		
	Bill No. 3		
	Masonry		
	CONSTRUCTION OF NEW MANKWENG TRADITIONAL COUNCIL OFFICE FOR COGHSTA		

R

	<u>Natural grey sills in single lengths bedded in class II mortar including metal fixing lugs etc</u>		
15	15 x 150mm Wide sills set flat and slightly projecting	m	66
	<u>Joint forming material in movement joints</u>		
16	12mm Fibre board built in vertically between concrete surface and brick skins	m2	16
	<u>FACE BRICKWORK</u>		
	<u>External facings in approved face bricks (FBS) with a PC Amount of R 5 500.00 per thousand bricks delivered to site (excluding VAT) pointed with square recessed horizontal and vertical joints</u>		
17	Extra over brickwork for face brickwork in foundation	m2	154
18	Extra over brickwork for external face brickwork	m2	378
19	Extra over brickwork for brick-on-edge header course lintels one course high, pointed on face and 110mm soffit	m	67
	<u>Brick-on-edge header course copings, sills, etc of Approved face bricks (FBS) with a PC Amount of R 3 500.00 per thousand bricks delivered to site (excluding VAT) pointed with polished recessed joints on all exposed faces</u>		
20	180mm Wide sill sloping and slightly projecting	m	66

Carried to Collection

R

Section No. 2
 Bill No. 3
 Masonry

**CONSTRUCTION OF NEW MANKWENG TRADITIONAL COUNCIL OFFICE
 FOR COGHSTA**

Section No. 2

Bill No. 3

Masonry

COLLECTION

Total Brought Forward from Page No.

**Page
No**

Amount

39

40

41

Carried Forward to Summary of Section No. 2

R

Section No. 2

Bill No. 3

Masonry

**CONSTRUCTION OF NEW MANKWENG TRADITIONAL COUNCIL OFFICE
FOR COGHSTA**

Item No	<u>SECTION No. 2 BILL No. 4</u>	Quantity	Rate	Amount
	<u>WATERPROOFING</u>			
	<u>PREAMBLES</u>			
	For Preambles see "Model Preambles For Trades"			
	<u>SUPPLEMENTARY PREAMBLES</u>			
	<u>Waterproofing</u>			
	Waterproofing of roofs, basements, etc shall be laid under a ten year guarantee. Waterproofing to roofs shall be laid to even falls to outlets etc with necessary ridges, hips and valleys. Descriptions of sheet or membrane waterproofing shall be deemed to include additional labour to turn-ups and turn-downs			
	Waterproofing to roofs shall be laid to even falls to outlets etc with necessary ridges, hips and valleys. Descriptions of sheet or membrane waterproofing shall be deemed to include additional labour to turn - ups and turn - downs			
	<u>DAMP-PROOFING OF WALLS AND FLOORS</u>			
	<u>One layer of 375 micron "Consol Plastics Brikgrip DPC" embossed damp proof course</u>			
1	In walls	m2	75	
2	In walls under cills	m2	29	
	<u>One layer of 250 micron "Consol plastics Gunplas black" waterproof sheeting sealed at laps " Gunplas pressure sensitive tape"</u>			
3	Under surface beds	m2	650	
	<u>WATERPROOFING TO ROOFS, BASEMENTS, ETC</u>			
	Carried to Collection			R
	Section No. 2 Bill No. 4 Waterproofing CONSTRUCTION OF NEW MANKWENG TRADITIONAL COUNCIL OFFICE FOR COGHSTA			

4	<p><u>4mm "Derbigum SP" waterproofing</u></p> <p>To upstands, etc</p>	m2	11
<p><u>JOINT SEALANTS ETC</u></p>			
5	<p><u>Two-part grey polysulphide sealing compound including backing cord, bond breaker, primer, etc</u></p> <p>10 x 15mm In expansion joints in floors including raking out expansion joint filler as necessary</p>	m	28

Carried to Collection

R

Section No. 2
 Bill No. 4
 Waterproofing

CONSTRUCTION OF NEW MANKWENG TRADITIONAL COUNCIL OFFICE FOR COGHSTA

Section No. 2

Bill No. 4

Waterproofing

COLLECTION

Total Brought Forward from Page No.

**Page
No**

43

44

Amount

Carried Forward to Summary of Section No. 2

R

Section No. 2

Bill No. 4

Waterproofing

**CONSTRUCTION OF NEW MANKWENG TRADITIONAL COUNCIL OFFICE
FOR COGHSTA**

Item No		Quantity	Rate	Amount
	<u>SECTION No. 2BILL No. 5</u>			
	<u>ROOF COVERING</u>			
	<u>PREAMBLES</u>			
	For Preambles see "Model Preambles For Trades"			
	<u>PROFILED METAL SHEETING AND ACCESSORIES</u>			
	<u>0,6mm "Brownbuilt Kliplock" steel sheet in single lengths fixed to steel rails and 900mm centres embossed galvanised sheet steel accessories</u>			
1	Roof covering with 25 degrees pitch	m2	816	
2	Ridge capping 550mm girth	m	83	
3	Valley cappings 550mm girth	m	21	
4	Hip capping 550mm girth	m	27	
	<u>SHEET METAL FLASHINGS, LININGS, COPINGS, ETC</u>			
	<u>0,6mm Galvanised sheet iron</u>			
5	Flashings	m2	1	
	<u>ROOF AND WALL INSULATION</u>			
	<u>"Sisalation 410" housing grade glass fibre reinforced aluminium foil bonded insulation</u>			
6	Insulation laid taut over purlins (at approximately 1,20mm centres) and fixed concurrent with roof covering including galvanised steel straining wires	m2	803	
	Carried Forward to Summary of Section No. 2			
	Section No. 2 Bill No. 5 Roof Coverings			R
	CONSTRUCTION OF NEW MANKWENG TRADITIONAL COUNCIL OFFICE FOR COGHSTA			

Item No	Quantity	Rate	Amount
<u>SECTION No. 2BILL No. 6</u>			
<u>CARPENTRY AND JOINERY</u>			
<u>PREAMBLES</u>			
For Preambles see "Model Preambles For Trades"			
<u>ROOFS ETC</u>			
<u>Roof guarantee</u>			
1	Allow for certificate under the control of a registered structural Engineer in accordance with SABS 0160 AND 0163		SUM
<u>Plate nailed timber roof truss construction</u>			
The following is applicable in respect of roof trusses:			
<p>Trusses are at maximum 760mm centres Roof covering is Double Roman Concrete Tiles on 38 x 38mm battens on Ceilings are 4mm Fibre Cement board ceiling The references given in the descriptions are to the respective types of trusses detailed on the architect's drawings numbered annexed to these bills of quantities/accompanying these bills of quantities for tender purposes The dimensions in the descriptions of the trusses are nominal and actual measurements are to be obtained from the architect and/or the site before design or fabrication commences</p>			
<u>ROOFS, ETC</u>			
Carried to Collection			R
Section No. 2 Bill No. 6 Carpentry CONSTRUCTION OF NEW MANKWENG TRADITIONAL COUNCIL OFFICE FOR COGHSTA			

Sawn softwood

2	Roof construction to double pitched roof with three hipped ends and one valley, 14.04 x 6.96m overall on plan x 1251mm high overall, including trusses, jack rafters, permanent bracing and 50 x 76mm purlins at 1000mm centres for roof covering (wall plates elsewhere)	No	2
3	Roof construction to double pitched roof one valley ends, 14.15 x 10.19m overall on plan x 1846mm high overall, including trusses, jack rafters, permanent bracing and 50 x 76mm purlins at 1000mm centres for roof covering (wall plates elsewhere)	No	1
4	Roof construction to double pitched roof with one valley ends, 13.92 x 10.19m overall on plan x 1846mm high overall, including trusses, jack rafters, permanent bracing and 50 x 76mm purlins at 1000mm centres for roof covering (wall plates elsewhere)	No	1
5	Roof construction to double pitched roof with gable ends, 9.97 x 6.96m overall on plan x 1251mm high overall, including trusses, jack rafters, permanent bracing and 50 x 76mm purlins at 1000mm centres for roof covering (wall plates elsewhere)	No	1

Wrought laminated Saligna

6	Purpose made pergola 50 x 150mm Bolted to steel beams and steel columns beams, etc	m	4
---	--	---	---

FACIAS, BARGE BOARDS, ETC:

7	12 x 225 mm Fibre cement barge board drilled and brass screwed and including steel jointing strips between lengths.	m	235
---	---	---	-----

SKIRTINGS Wrought Meranti

8	19 x 76mm Skirting nailed to walls with heads of nails punched and filled including 19mm quadrant bead planted on at junction with floor	m	23
---	--	---	----

Carried to Collection

R

Section No. 2
 Bill No. 6
 Carpentry

CONSTRUCTION OF NEW MANKWENG TRADITIONAL COUNCIL OFFICE FOR COGHSTA

DOORS

NOTE

All framed and ledged batten doors and combination doors, where battens are utilised, shall only be of construction acceptable SABS, i.e. mortice and tenon where the tenon is exposed on the outside edges of styles and where the tenon is wedged to form a dovetailed shape

Semi-solid core door with 3mm thick tampered Hardboard sides and concealed hardware edges

9	44 mm Door, size 813 x 2032 mm.	No	14
---	---------------------------------	----	----

Solid core door with 3mm thick tampered Hardboard sides and concealed hardware edges

10	44 mm Door, size 813 x 2032 mm.	No	7
----	---------------------------------	----	---

11	44 mm Door, size 900 x 2032 mm.	No	2
----	---------------------------------	----	---

12	44 mm Double door, size 1511 x 2032mm.	No	1
----	--	----	---

Wrought meranti doors hung to steel frames

13	44mm Framed, ledged and braced batten door 813 x 2032mm high of 150mm wide top rail and stiles, 22 x 150mm middle ledge and braces and 22 x 220mm bottom ledge, filled in with 22mm tongued and grooved V-jointed one side vertical boarding with tongued and grooved joints to top rail and stiles and with inner edges of framing and abutting edges of boarding chamfered to form V-joint	No	7
----	--	----	---

BUDGETARY ALLOWANCES

14	Provide the sum of R 30 000-00 (Thirty thousand Rand) for the Sectional Overhead Sliding Double Garage Door installed complete.		
----	---	--	--

Item	30 000.00
------	-----------

Carried to Collection

R

Section No. 2
 Bill No. 6
 Carpentry

CONSTRUCTION OF NEW MANKWENG TRADITIONAL COUNCIL OFFICE FOR COGHSTA

Section No. 2

Bill No. 6

Carpentry

COLLECTION

Total Brought Forward from Page No.

**Page
No**

Amount

47

48

49

Carried Forward to Summary of Section No. 2

R

Section No. 2

Bill No. 6

Carpentry

**CONSTRUCTION OF NEW MANKWENG TRADITIONAL COUNCIL OFFICE
FOR COGHSTA**

Item No	<u>SECTION No. 2BILL No. 7</u>	Quantity	Rate	Amount
	<u>CEILING, PARTITIONS AND ACCESS FLOORING</u>			
	<u>PREAMBLES</u>			
	For Preambles see "Model Preambles For Trades"			
	<u>SUPPLEMENTARY PREAMBLES</u>			
	<u>Descriptions:</u>			
	Items described as "nailed" shall be deemed to be fixed with hardened steel nails or pins or shot pinned to brickwork or concrete			
	Items described as "plugged" shall be deemed to include screwing to fibre, plastic or metal plugs at not exceeding 600mm centres, and where described as "bolted" the bolts have been given elsewhere			
	<u>CEILING ETC</u>			
	<u>NAILED UP CEILING</u>			
	<u>12,5mm "Rhino" gypsum plasterboard with taped and skimmed joints finished with one coat rhinolite plaster</u>			
1	Ceilings including 38 x 38mm sawn softwood brander at 350mm centres	m2	447	
2	Extra over ceiling for opening of 650 x 650mm trap door complete with trimmers, frame,etc	No	11	
	<u>Cornices</u>			
3	50 mm Fibre cement coved cornice planted on including mitres, etc.	m	456	
	<u>SUSPENDED CEILING</u>			
	Carried to Collection			R
	Section No. 2 Bill No. 7 Ceilings, partitions and Access Flooring			
	CONSTRUCTION OF NEW MANKWENG TRADITIONAL COUNCIL OFFICE FOR COGHSTA			

Pre-painted 600 x 1200 x 17mm "Armstrong Fine Fissured 95% RH" or equally approved acoustic panels on aluminium pre-painted exposed tee suspension system including main and cross tees, necessary hangers, grids, etc

4	Ceilings suspended not exceeding 1m below steel trusses	m2	205
---	---	----	-----

Cornices to suspended ceilings

5	25 x 25mm Angle profile cornice	m	103
---	---------------------------------	---	-----

Aerolite insulation

6	50mm Thick insulation laid on ceiling boards	m2	650
---	--	----	-----

Carried to Collection

R

Section No. 2

Bill No. 7

Ceilings, partitions and Access Flooring

CONSTRUCTION OF NEW MANKWENG TRADITIONAL COUNCIL OFFICE FOR COGHSTA

Section No. 2

Bill No. 7

Ceilings, partitions and Access Flooring

COLLECTION

Total Brought Forward from Page No.

**Page
No**

51

52

Amount

Carried Forward to Summary of Section No. 2

R

Section No. 2

Bill No. 7

Ceilings, partitions and Access Flooring

**CONSTRUCTION OF NEW MANKWENG TRADITIONAL COUNCIL OFFICE
FOR COGHSTA**

Item No	<u>SECTION No. 2 BILL No. 8</u>	Quantity	Rate	Amount
	<u>FLOOR COVERINGS, WALL LININGS, ETC.</u>			
	<u>PREAMBLES</u>			
	For Preambles see "Model Preambles For Trades"			
	All materials shall be in colours to be selected by the Representative/Agent and, where applicable, laid to approved patterns			
	<u>FLOOR COVERINGS</u>			
	<u>500 x 500mm "Nexus Berber Point" or equally approved carpet tiles</u>			
1	On floors	m2	1	
	Carried Forward to Summary of Section No. 2			R
	Section No. 2 Bill No. 8 Floor Coverings, Wall Linings, etc. CONSTRUCTION OF NEW MANKWENG TRADITIONAL COUNCIL OFFICE FOR COGHSTA			

Item No	Quantity	Rate	Amount
<p><u>IRONMONGERY</u></p>			
<p><u>SECTION No. 2 BILL No. 9</u></p>			
<p><u>PREAMBLES</u></p>			
<p>For Preambles see "Model Preambles For Trades"</p>			
<p><u>SUPPLEMENTARY PREAMBLES</u></p>			
<p>Items, materials or methods to be used specified by trade names or catalogue numbers are only an indication of the quality required. Items, materials or methods of similar quality may be used with prior approval from the architect</p>			
<p><u>Finishes to ironmongery</u></p>			
<p>Where applicable finishes to ironmongery are indicated by suffixes in accordance with the following list BS Satin bronze lacquered CH Chromium plated SC Satin chromium plated SE Silver enamelled GE Grey enamelled AS Anodised silver AB Anodised bronze AG Anodised gold ABL Anodised black PB Polished brass PL Polished and lacquered PT Epoxy coated SD Sanded</p>			
<p><u>Fixing</u></p>			
<p>Items described as "plugged" shall be deemed to include screwing to fibre, plastic or metal plugs in brickwork or concrete</p>			
<p><u>References</u></p>			
<p>References in brackets at the end of descriptions refer to the Architect's schedules</p>			
<p><u>LOCKS</u></p>			
<p>Carried to Collection</p>			
<p>Section No. 2 Bill No. 9 Ironmongery</p>			
<p>CONSTRUCTION OF NEW MANKWENG TRADITIONAL COUNCIL OFFICE FOR COGHSTA</p>			
		R	

"Union"

1	Three lever double cylinder lockset code 2222 or similar with Gower Handel code CZ682-05 SC complete with striking plate fixed to metal	No	36
2	Four-lever lockset with striking plate fixed to metal	No	7
3	DMWS-SS-008 or similar Bathroom /WC small case deadlock	No	8

LETTERS, NAMEPLATES, ETC

4	DSS4 'Wheelchair' or similar pictogram on 76mm diameter stainless steel plate	No	2
5	DSS2 'Female' or similar pictogram on 76mm diameter stainless steel plate	No	2
6	DSS1 'Male' or similar pictogram on 76mm diameter stainless steel plate	No	3

SUNDRIES

"Dorma " or similar approved

7	AL87722AS Hat and coat hook with rubber tip	No	10
8	Approved Aluminium door stop with rubber insert	No	50
9	Overhead surface mounted type door closer with aluminium casing	No	8

"Kimberley Clark" or similar approved

10	Approved soap dispenser, top-up system with 800ml capacity fixed against wall in positions as shown on detail layouts and details, all as per manufacturers spec	No	8
11	Approved stainless steel 3m toilet paper dispenser fixed against wall as per manufacturers specifications	No	8
12	425792 'Kim dry' 650mm towel dispenser rail fixed against wall as per manufacturers spec	No	8

Carried to Collection

R

Section No. 2
 Bill No. 9
 Ironmongery

CONSTRUCTION OF NEW MANKWENG TRADITIONAL COUNCIL OFFICE FOR COGHSTA

Section No. 2

Bill No. 9

Ironmongery

COLLECTION

Total Brought Forward from Page No.

**Page
No**

55

56

Amount

Carried Forward to Summary of Section No. 2

R

Section No. 2

Bill No. 9

Ironmongery

**CONSTRUCTION OF NEW MANKWENG TRADITIONAL COUNCIL OFFICE
FOR COGHSTA**

Item No	SECTION No. 2 BILL No. 10	Quantity	Rate	Amount
	<p><u>STRUCTURAL STEELWORK</u></p> <p><u>PREAMBLES</u></p> <p>For Preambles see "Model Preambles For Trades"</p> <p><u>SUPPLEMENTARY PREAMBLES</u></p> <p><u>Descriptions</u></p> <p>Descriptions of bolts shall be deemed to include nuts and washers</p> <p>Descriptions of L-shaped and U-shaped anchor bolts shall be deemed to include bending, threading, nuts and washers and embedding in concrete</p> <p>Descriptions of expansion anchors and bolts and chemical anchors and bolts shall be deemed to include nuts, washers and mortices in brickwork or concrete</p> <p>Descriptions of L-shaped and U-shaped anchor bolts shall be deemed to include bending, threading, nuts and washers and embedding in concrete. Where anchor bolts are described as embedded in sides or soffits of concrete it shall be deemed to include holes through formwork.</p> <p>Descriptions of expansion anchors and bolts and chemical anchors and bolts shall be deemed to include nuts, washers and mortices in brickwork or concrete.</p> <p><u>GLAVANISED STEEL COLUMNS AND BEAMS</u></p> <p><u>Welded columns in single length, with flat section base, top, bearer and connection plates bolted to reinforced concrete at bottom and parallel flanged channel top</u></p>			
1	100mm x 3mm x 4.53kg/m circular hollow section column	t 0.53		
	Carried to Collection			R
	<p>Section No. 2 Bill No. 10 Structural Steel work CONSTRUCTION OF NEW MANKWENG TRADITIONAL COUNCIL OFFICE FOR COGHSTA</p>			

2	150 x 150 x 10mm Base plates including 4 no . holes to suite m16 bolts. bolts included	No	4
3	150 x 150 x 10mm Top connector plates including 2 no . holes to suite m16 bolts. bolts included	No	4

Carried to Collection

R

Section No. 2
 Bill No. 10
 Structural Steel work

**CONSTRUCTION OF NEW MANKWENG TRADITIONAL COUNCIL OFFICE
 FOR COGHSTA**

Section No. 2

Bill No. 10

Structural Steel work

COLLECTION

Total Brought Forward from Page No.

**Page
No**

58

59

Amount

Carried Forward to Summary of Section No. 2

R

Section No. 2

Bill No. 10

Structural Steel work

**CONSTRUCTION OF NEW MANKWENG TRADITIONAL COUNCIL OFFICE
FOR COGHSTA**

Item No	SECTION No. 2BILL No. 11	Quantity	Rate	Amount
	<p><u>METALWORK</u></p> <p><u>PREAMBLES</u></p> <p>For Preambles see "Model Preambles For Trades"</p> <p><u>SUPPLEMENTARY PREAMBLES</u></p> <p><u>Descriptions</u></p> <p>Descriptions of bolts shall be deemed to include nuts and washers</p> <p>Descriptions of expansion anchors and bolts and chemical anchors and bolts shall be deemed to include nuts, washers and mortices in brickwork or concrete</p> <p>Metalwork described as "bolted" shall be deemed to exclude the bolts unless otherwise described</p> <p><u>Hot-dipped double spelter galvanised mild steel grab rails formed of 32mm outside diameter x 1,6mm round section rails and 75mm diameter x 3mm flat section fixing flanges each three times holed and bolted to walls with M8 x 50mm expansion bolts</u></p>			
1	32mm Grab rail 700mm long with two 80mm return ends bolted	No	4	
	<p><u>PRESSED STEEL GATES</u></p> <p><u>The following in framed and welded mild steel security gates and fixing in position complete</u></p>			
2	2100 x 900mm Steel gate comprising of 75 x 50 x 2mm square tubing outer frame and 20 x 20mm square tubing verticals at 120mm centres	No	6	
	Carried to Collection			R
	Section No. 2 Bill No. 11 Metalwork			
	CONSTRUCTION OF NEW MANKWENG TRADITIONAL COUNCIL OFFICE FOR COGHSTA			

PRESSED STEEL DOOR FRAMES

NOTE

The rates for door frames shall include for welding of all hinge pins at completion

1,2mm thick Double rebated mild steel door frames suitable for half brick walls. Frame complete with one pair standard butt hinges and factory applied primer

3	Frame for door 813 x 2032mm high	No	7
---	----------------------------------	----	---

4	Frame for door 813 x 2032mm high and fixed fanlight 305mm high	No	10
---	--	----	----

1,2mm thick Double rebated mild steel door frames suitable for one brick walls. Frame complete with one pair standard butt hinges and factory applied primer

5	Frame for door 813 x 2 032mm high	No	9
---	-----------------------------------	----	---

6	Frame for door 813 x 2032mm high and fixed fanlight 305mm high	No	2
---	--	----	---

7	Frame for door 914 x 2 032mm high	No	2
---	-----------------------------------	----	---

8	Frame for door 1 511 x 2 032mm high	No	1
---	-------------------------------------	----	---

STEEL RECORDROOM AND STRONGROOM DOORS, VENTILATORS, ETC

"Mutual" strongroom doors etc suitable for 230mm walls fixed to brickwork or concrete

9	"Mutual DS3 CAT2" strongroom door and frame 775 x 1875mm high overall with a mass of 380kg	No	2
---	--	----	---

STEEL WINDOWS, DOORS, ETC

Carried to Collection

R

Section No. 2
 Bill No. 11
 Metalwork

CONSTRUCTION OF NEW MANKWENG TRADITIONAL COUNCIL OFFICE FOR COGHSTA

Standard residential windows with 10mm square burglar bars to fixed lights and opening sashes

10	Window type NE1, 533 x 654mm high	No	9
11	Window type NCT1S, 533 X 949mm high	No	3
12	Window type ND2, 1022 x 1245mm high	No	20
13	Window type ND4, 1511 x 1245mm high	No	8
14	Window type NE8, 1022 x 654mm high	No	6
15	Window type NG2, 1022 x 359mm high	No	6

ALUMINIUM SLIDING DOORS

Natural anodised sliding doors as per "AAMSA specification" system, complete with subframes, ironmongery, glass, sealing, etc and fixing to brickwork or concrete

16	Standard door type OXXO 147 (4221), 4100 x 2095mm high (W8)	No	1
----	---	----	---

ALUMINIUM SHOPFRONTS

Natural anodized shopfronts as per AAMSA spec complete with subframes, ironmongery, glass, sealing, etc and fixing to brickwork or concrete

17	Purpose made shopfront, 6780 x 2510mm high with one double door 1800 x 2510mm high with two corner and side fixture of 2580 x 2510mm each (W7)	No	1
----	--	----	---

Carried to Collection

R

Section No. 2
 Bill No. 11
 Metalwork

CONSTRUCTION OF NEW MANKWENG TRADITIONAL COUNCIL OFFICE FOR COGHSTA

Section No. 2

Bill No. 11

Metalwork

COLLECTION

Total Brought Forward from Page No.

**Page
No**

Amount

61

62

63

Carried Forward to Summary of Section No. 2

R

Section No. 2

Bill No. 11

Metalwork

**CONSTRUCTION OF NEW MANKWENG TRADITIONAL COUNCIL OFFICE
FOR COGHSTA**

Item No		Quantity	Rate	Amount
	<u>SECTION No. 2BILL No. 12</u>			
	<u>PLASTERING</u>			
	<u>PREAMBLES</u>			
	For Preambles see "Model Preambles For Trades"			
	<u>SCREEDS</u>			
	<u>Screeds on concrete</u>			
1	25mm Thick on floors	m2	650	
	<u>INTERNAL PLASTER</u>			
	<u>Cement plaster on brickwork</u>			
2	On vertical surfaces	m2	1 488	
3	On narrow widths	m2	21	
	<u>EXTERNAL PLASTER</u>			
	<u>Cement plaster on brickwork</u>			
4	On walls	m2	26	
5	On narrow width	m2	1	
	<u>CORNER PROTECTORS,DIVIDING STRIPS,ETC</u>			
6	30 X 3mm Flat section brass dividing strip between different floor finishes	m	11	
	Carried Forward to Summary of Section No. 2			
	Section No. 2			
	Bill No. 12			
	Plastering			
	CONSTRUCTION OF NEW MANKWENG TRADITIONAL COUNCIL OFFICE FOR COGHSTA			
				R

Item No	SECTION No. 2BILL No. 13	Quantity	Rate	Amount
	<p><u>TILING</u></p> <p><u>PREAMBLES</u></p> <p>For Preambles see "Model Preambles For Trades"</p> <p><u>SUPPLEMENTARY PREAMBLES</u></p> <p>Unless described as "fixed with adhesive to plaster (plaster elsewhere)" descriptions of tiling on brick or concrete walls columns, etc shall be deemed to include 1:4 cement plaster backing and descriptions of tiling on concrete floors etc shall be deemed to include 1:3 plaster bedding</p> <p><u>WALL TILING</u></p> <p><u>198 x 198 x 6mm White glazed ceramic wall tiles fixed with an approved tile adhesive to plaster (elsewhere measured) and jointed with waterproofing coloured jointing compound</u></p>			
1	On vertical surfaces	m2	149	
	<p><u>FLOOR TILING</u></p> <p><u>Approved 600 x 600mm bodied Porcelain floor tiles (PC Amount of R300 excluding VAT) fixed on 25mm screed (elsewhere measured) flush pointed with tinted waterproof jointing compound and approved adhesive</u></p>			
2	On floors and landings	m2	637	
3	Skirting 75mm high (of cut tiles)	m	358	
	<p>Carried Forward to Summary of Section No. 2</p> <p>Section No. 2 Bill No. 13 Tiling</p> <p>CONSTRUCTION OF NEW MANKWENG TRADITIONAL COUNCIL OFFICE FOR COGHSTA</p>			R

Item No		Quantity	Rate	Amount
	<u>SECTION No. 2BILL No. 14</u>			
	<u>PLUMBING AND DRAINAGE (PROVISIONAL)</u>			
	<u>PREAMBLES</u>			
	For Preambles see "Model Preambles For Trades"			
	<u>RAINWATER DISPOSAL</u>			
	<u>0.6mm Galvanised sheet steel gutters and rainwater pipes with powder coated finish on outside.</u>			
1	100 x 75mm Rainwater pipes	m	159	
2	Extra over gutter for stopped end	No	2	
3	Extra over gutter for angle	No	2	
4	Extra over gutter for outlet for 75 x 75mm pipe	No	13	
5	100 x 75mm diameter gutter, etc	m	36	
6	Extra over rainwater pipe for bend	No	26	
7	Extra over rainwater pipe for eaves or plinth offset	No	13	
8	Extra over rainwater pipes for shoe	No	13	
	<u>STORMWATER CHANNEL</u>			
	<u>Rectangular cast in situ concrete surface water channels</u>			
9	100mm Thick shallow equal 'V' shaped rectangular 20MPa concrete drainage channel 1m wide overall including all earthworks, formwork and ref 193 mesh reinforcement cast in panels not exceeding 3m long, backfilling etc and finishing tops and sides smooth with woodfloat	m	1	
	Carried to Collection			
	Section No. 2 Bill No. 14 Plumbing and Drainage (Provisional) CONSTRUCTION OF NEW MANKWENG TRADITIONAL COUNCIL OFFICE FOR COGHSTA			R

10	Extra over for angles, intersections, ends, dressing into sides of catchpits, etc	No	1	
	<u>SANITARY FITTINGS</u>			
	<u>Approved Water Tanks, etc</u>			
11	5000 litre Plastic Water tank for rain harvesting including installation	No	3	
	<u>'Vaal' or equally approved</u>			
12	635 x 485mm "Lotus" White vitreous china basin (code 7026) with three semi-punched tap holes and 301 slotted waste with plug and chain, with intergrated overflow mounted using universal half pedestal and hanger mechanism (code 715221)	No	12	
	<u>'Vaal' or equally approved</u>			
13	"Concorde" White vitreous china close coupled WC suite comprising 90 degrees outlet closed rim washdown pan (product code 7727700) and matching 9 litre top dual flush cistern (product code 7104DT) complete with lid, fitments and purpose made wooden seat (Code 852720)	No	6	
14	"Protea" Paraplegic white vitreous china floor mounted paraplegic WC pan (product code 750200) comprising 90 degrees outlet pan (product code 750200) and matching 9 litre cistern (product code 710631) including lid, fitment and purpose made chrome plated side flush lever	No	2	
	<u>'Vaal' or equally approved</u>			
15	Approved flat back wall mounted bowl urinal fixed with matching brackets, one C.P. flush valve complete with flush pipes as required and one approved C.P. plated bottle trap	No	2	
Carried to Collection				
Section No. 2				
Bill No. 14				
Plumbing and Drainage (Provisional)				
CONSTRUCTION OF NEW MANKWENG TRADITIONAL COUNCIL OFFICE FOR COGHSTA				
				R

<u>'Franke' sink or equally approved</u>		
16	Approved 535 x 455mm Type 304 Stainless steel drip sink with 100mm splash back, grid, etc on 25 x 25mm brackets all as supplied by manufacturers installed 500 mm F.F.L, one 20mm C.P hose bib cock 1000mm F.F.L, one 40mm diameter C.P outlet an one 40mm diameter C.P bottle trap	No 1
17	Single bowl 900mm x 500mm Type 304 stainless steel inlay type fixed onto kitchen unit, one approved C.P mixer, one 40mm diameter C.P outlet and one one approved 40mm diameter C.P. bottle trap	No 1
<u>WASTE UNIONS</u>		
<u>Cobra Watertech</u>		
18	40mm 316 CP sink waste union	No 3
<u>TRAPS ETC</u>		
<u>Traps, etc. including joints to steel pipes and/or fittings unless otherwise described</u>		
19	40mm Deep seal "P" or "S" trap	No 15
<u>Chromium plated</u>		
20	Flexible connectors, etc.	No 24
<u>TAPS, VALVES, ETC</u>		
<u>Valves, etc. including joints to steel pipes and/or fittings unless otherwise described</u>		
21	15mm Chromium plated full way ballcock shut-off control valve with screw type control	No 3
22	15mm Brass stopcock	No 28
<u>Cobra Watertech or equally approved</u>		
23	15mm Chromium sink mixer (Code 266/04/10)	No 1
24	Selene 953, pillartap	No 22

Carried to Collection

R

Section No. 2

Bill No. 14

Plumbing and Drainage (Provisional)

CONSTRUCTION OF NEW MANKWENG TRADITIONAL COUNCIL OFFICE FOR COGHSTA

WATER SUPPLIES**Class 1 copper pipes with capillary couplings**

25	15mm Pipe fixed in and including chase in walls	m	184
----	---	---	-----

26	22mm Pipe fixed in and including chase in walls	m	61
----	---	---	----

Extra over copper pipes for capillary fittings

27	15mm Fittings	No	60
----	---------------	----	----

28	22mm Fittings	No	22
----	---------------	----	----

SUBSOIL DRAINAGE**uPVC pipes**

29	50mm Pipes fixed to walls, etc.	m	52
----	---------------------------------	---	----

30	110mm Pipes fixed to walls, etc.	m	19
----	----------------------------------	---	----

31	110mm Pipes laid in and including trenches not exceeding 1m deep	m	181
----	--	---	-----

Extra over uPVC pipes for fittings

32	50mm Bend	No	22
----	-----------	----	----

33	50mm Access bend	No	6
----	------------------	----	---

34	110mm Bend	No	25
----	------------	----	----

35	110mm Tee junction	No	11
----	--------------------	----	----

36	110 x 50 mm Reducing junction	No	6
----	-------------------------------	----	---

THE FOLLOWING IN SEPTIC TANK AND FRENCH DRAIN**Earthworks for Septic tank and Conservative drain**

37	Excavation in earth excavation n.e 2m	m3	1
----	---------------------------------------	----	---

Carried to Collection

R

Section No. 2

Bill No. 14

Plumbing and Drainage (Provisional)

CONSTRUCTION OF NEW MANKWENG TRADITIONAL COUNCIL OFFICE FOR COGHSTA

38	Excavation in earth excavation 2m and not exceeding 4m deep	m3	1	
	<u>Earth filling of clean drain rock</u>			
39	As backfilling for drain pipe	m3	1	
	<u>Earth filling obtained from the excavations and/or prescribed stock piles on site compacted to 90% Mod AASHTO density</u>			
40	As backfilling to drain pipe	m3	1	
	<u>Concrete, Formwork and Reinforcement for Septic tank</u>			
41	20Mpa Reinforced Concrete in bottoms	m3	1	
42	25Mpa Reinforced Concrete in slab	m3	1	
43	Type 193 fabric reinforcement in concrete bottoms	m2	1	
44	Type 617 fabric reinforcement in concrete bottoms	m2	1	
	<u>Masonry for Septic tank</u>			
45	Half Brick wall	m2	1	
46	One Brick wall	m2	1	
	<u>Plastering for Septic tank</u>			
47	13mm thick Cement plaster on brick walls	m2	1	
48	610 x 610 x 97kg Type 2B Mild steel Manhole cover and frame	No	1	
	<u>Sundries</u>			
49	110 diameter drain	m	1	
50	Double layer of Geofabric	m2	1	
	<u>FIRE SERVICES</u>			
	Carried to Collection			R
	Section No. 2			
	Bill No. 14			
	Plumbing and Drainage (Provisional)			
	CONSTRUCTION OF NEW MANKWENG TRADITIONAL COUNCIL OFFICE FOR COGHSTA			

<u>Fire appliances including piping, etc</u>				
51	4,5kg DCP dry powder portable fire extinguisher on and including wrought Meranti backboard size 520 x 100 x 22mm thick plugged and screwed to wall and finished with two coats of polyurethane varnish, including 120 x 20 x 2mm mild steel strip bent to form hook	No	7	
52	Fire hose reel complete with 30m rubber hose, chromium plated stopcock, shut-off nozzle and wall bracket bolted to wall with and including expansion bolts	No	2	
<u>ELECTRIC WATER HEATERS</u>				
53	100 Litre horizontal wall mounted electric water heater	No	1	
<u>TESTING</u>				
54	Testing soil drainage system		Item	
55	Testing waste pipe system		Item	
56	Testing water pipe system		Item	
<u>BUDGETARY ALLOWANCES</u>				
57	Water to supply fire appliances		Item	
58	Provide the sum of R 16 500.00 (Sixteen Thousand five hundred Rand) for the construction of a 3 x Plinths for the Water Tanks (elsewhere measured)		Item	16 500.00
59	Provide the sum of R 80 000.00 (Eighty Thousand Rand) for the construction of a Septic Tank and French Drain		Item	80 000.00
Carried to Collection				
				R
Section No. 2 Bill No. 14 Plumbing and Drainage (Provisional) CONSTRUCTION OF NEW MANKWENG TRADITIONAL COUNCIL OFFICE FOR COGHSTA				

Section No. 2

Bill No. 14

Plumbing and Drainage (Provisional)

COLLECTION

Total Brought Forward from Page No.

**Page
No**

Amount

67

68

69

70

71

72

Carried Forward to Summary of Section No. 2

R

Section No. 2

Bill No. 14

Plumbing and Drainage (Provisional)

**CONSTRUCTION OF NEW MANKWENG TRADITIONAL COUNCIL OFFICE
FOR COGHSTA**

Item No		Quantity	Rate	Amount
	<u>SECTION No. 2BILL No. 15</u>			
	<u>GLAZING</u>			
	<u>PREAMBLES</u>			
	For Preambles see "Model Preambles For Trades"			
	<u>GLAZING TO STEEL WITH PUTTY</u>			
	<u>6mm Clear float glass</u>			
1	<u>Panes</u> exceeding 0,1m ² and not exceeding 0,5m ²	m2	3	
2	Panes exceeding 0,5m ² and not exceeding 2m ²	m2	41	
	<u>6mm obscure glass</u>			
3	Panes exceeding 0,1m ² and not exceeding 0,5m ²	m2	6	
	<u>MIRRORS, SHELVES, ETC</u>			
	<u>6 mm Silvered float glass copper backed mirrors</u>			
4	600 x 450 x 6mm Thick SABS Approved mirror with building paper at back fixed against wall with four C.P. capped mirror screens in position as shown on detail layout	No	12	
	Carried Forward to Summary of Section No. 2			
	Section No. 2			
	Bill No. 15			
	Glazing			
	CONSTRUCTION OF NEW MANKWENG TRADITIONAL COUNCIL OFFICE FOR COGHSTA			
				R

Item No		Quantity	Rate	Amount
	<u>SECTION No. 2BILL No. 16</u>			
	<u>PAINTWORK</u>			
	<u>PREAMBLES</u>			
	For Preambles see "Model Preambles For Trades"			
	<u>ON FLOATED PLASTER</u>			
	<u>Prepare, stop and apply one coat alkali resistant primer, one coat universal undercoat and two full coats eggshell enamel paint</u>			
1	On internal plastered walls	m2	1 508	
2	On external plastered walls	m2	27	
	<u>ON PLASTER BOARD</u>			
	<u>One coat primer and two coats interior quality PVA emulsion paint</u>			
3	On ceilings and cornices	m2	650	
	<u>ON FIBRE CEMENT</u>			
	<u>One coat primer and two coats exterior quality PVA emulsion paint</u>			
4	On fascias and barge boards	m2	107	
	<u>ON METAL</u>			
	<u>One primer, one undercoat and two coats alkyd enamel paint on steel</u>			
5	On grille gates and screens (both sides measured on flat)	m2	21	
	Carried to Collection			
	Section No. 2			
	Bill No. 16			
	Paintwork			
	CONSTRUCTION OF NEW MANKWENG TRADITIONAL COUNCIL OFFICE FOR COGHSTA			
				R

	<u>One coat undercoat and two coats polyurethane enamel. Sandpaper lightly between coats. Colour to be determined on site</u>		
6	On windows with burglar bars	m2	98
7	On door frames	m2	38
	<u>ON WOOD</u>		
	<u>One coat wood primer, one undercoat and two coats alkyd enamel paint</u>		
8	On doors	m2	83
	<u>Three coats polyurethane suede varnish</u>		
9	On skirtings, rails, etc. not exceeding 300mm girth	m	2
10	On doors	m2	24

Carried to Collection

R

Section No. 2
Bill No. 16
Paintwork

**CONSTRUCTION OF NEW MANKWENG TRADITIONAL COUNCIL OFFICE
FOR COGHSTA**

Section No. 2

Bill No. 16

Paintwork

COLLECTION

Total Brought Forward from Page No.

**Page
No**

75

76

Amount

Carried Forward to Summary of Section No. 2

R

Section No. 2

Bill No. 16

Paintwork

**CONSTRUCTION OF NEW MANKWENG TRADITIONAL COUNCIL OFFICE
FOR COGHSTA**

SECTION SUMMARY - BUILDING WORK

Bill No		Page No	Amount
1	Earthworks (Provisional)	35	
2	Concrete, Formwork & Reinforcement	38	
3	Masonry	42	
4	Waterproofing	45	
5	Roof Coverings	46	
6	Carpentry	50	
7	Ceilings, partitions and Access Flooring	53	
8	Floor Coverings, Wall Linings, etc.	54	
9	Ironmongery	57	
10	Structural Steel work	60	
11	Metalwork	64	
12	Plastering	65	
13	Tiling	66	
14	Plumbing and Drainage (Provisional)	73	
15	Glazing	74	
16	Paintwork	77	
Carried to Final Summary			
Section No. 2 CONSTRUCTION OF NEW MANKWENG TRADITIONAL COUNCIL OFFICE FOR COGHSTA			R

Item No	SECTION No. 3 BILL No. 1	Quantity	Rate	Amount
	<u>PLATFORMS</u>			
	<u>PREAMBLES</u>			
	For Preambles see "Model Preambles For Trades"			
	<u>Open face excavation over sloping site</u>			
1	Open face excavation to form platform under parking areas etc and depositing excavated material over site including haulage not exceeding 1km from perimeter of excavations	m3	956	
	<u>Extra over all excavations for carting away</u>			
2	Surplus material from stock piles on site to a dumping site to be located by the contractor	m3	717	
	<u>Compaction of surfaces</u>			
3	Compaction of ground surface areas etc. by wetting and compacting with vibratory roller	m2	1 593	
	Carried to Collection			
	Section No. 3 Bill No. 1 Platforms			R
	CONSTRUCTION OF NEW MANKWENG TRADITIONAL COUNCIL OFFICE FOR COGHSTA			

4	<p><u>Keeping excavations free of water</u></p> <p>Keeping excavations free of all water other than subterranean water</p>		Item	
5	<p><u>Earth filling supplied by the contractor overplatform base etc</u></p> <p>Over site of G6 material in accordance with SABS 1200 DM compacted to 95% Mod AASHTO density in 150mm layers</p>	m3	956	
6	<p><u>Prescribed density tests on filling</u></p> <p>In-situ dry density (sand replacement) test in accordance with method A10 (a) of TMH 1</p>	No	120	
Carried to Collection				R
<p>Section No. 3 Bill No. 1 Platforms CONSTRUCTION OF NEW MANKWENG TRADITIONAL COUNCIL OFFICE FOR COGHSTA</p>				

Section No. 3

Bill No. 1

Platforms

COLLECTION

Total Brought Forward from Page No.

**Page
No**

79

80

Amount

Carried Forward to Summary of Section No. 3

R

Section No. 3

Bill No. 1

Platforms

**CONSTRUCTION OF NEW MANKWENG TRADITIONAL COUNCIL OFFICE
FOR COGHSTA**

Item No	<u>SECTION No. 3BILL No. 2</u>	Quantity	Rate	Amount
	<u>ROADS AND PARKING</u>			
	<u>PREAMBLES</u>			
	For Preambles see "Model Preambles For Trades"			
	<u>EXCAVATION, FILLING, ETC OTHER THAN BULK</u>			
	<u>Excavation</u>			
1	Open face excavation in earth to reduce levels	m3	602	
2	Extra over all excavations for carting away surplus material from excavations and/or from stockpiles on site to a dumping site to be located by the Contractor	m3	301	
3	Extra over open face excavations in earth for excavations in soft rock	m3	60	
4	Extra over open face excavations in earth for excavations in hard rock	m3	30	
5	Allow for keeping all excavations entirely free from water and mud		Item	
	<u>Filling, etc.</u>			
6	Earth filling from the excavations to make up levels around buildings compacted to 90% modified AASHTO density	m3	301	
7	Imported natural gravel material (minimum G5/6 material to TRH14) supplied by the Contractor and brought onto site from commercial sources in filling under paving, etc compacted in layers not exceeding 150mm thick to 90% modified AASHTO density	m3	622	
8	Base layer of imported natural gravel material (minimum G1 material to TRH14) supplied by the Contractor and brought onto site from commercial sources and compacted to 100% modified AASHTO density	m3	151	
	Carried to Collection			R
	Section No. 3 Bill No. 2 Roads and Parking			
	CONSTRUCTION OF NEW MANKWENG TRADITIONAL COUNCIL OFFICE FOR COGHSTA			

9	Compaction of ground surface under pavings, etc. including scarifying for a depth of 150mm, breaking down oversize material, adding suitable material where necessary and compact to 93% modified AASHTO density	m2	1 004	
10	50mm Thick clean, dry, riversand layer treated with an approved weed killer at the rate of 50 grams per square metre, spread and levelled to receive paving blocks (elsewhere)	m2	1 004	
	<u>Tests</u>			
11	Tests to determine the degree of compaction, etc. of ground or filling	No	20	
	<u>PRECAST CONCRETE</u>			
12	85mm Interlocking concrete paving blocks in accordance with SABS Specification 1058 and laid to falls on sand layer (elsewhere) with joints filled in with sand and vibrated, including all straight cutting	m2	1 500	
13	Mountable kerbing to SABS 927 Fig. 3 in 1m lengths with 10mm wide butt joints filled in with (1:3) cement/sand mortar and pointed with grooved half round joints and 10mm wide open butt joints at 3m centres including 15MPa/19mm mass concrete bedding size 30mm thick x 400mm wide and 20MPa/19mm mass concrete hunching size 112.5mm long x 112.5mm high x 85mm thick at joints and backfilling at back of kerbs, topsoiled and levelled to adjacent surfaces	m	180	
	<u>ROAD MARKINGS</u>			
	<u>Prepare and apply one coat white reflective road marking paint on precast concrete paving blocks, etc</u>			
14	100mm Wide line	m	60	
15	60mm Letter-STOP	No	8	
	<u>BUDGETARY ALLOWANCES</u>			
16	Provide the sum of R 220 000-00 (Two hundred and Twenty thousand Rand) for Storm water Drainage		Item	220 000.00
Carried to Collection				
				R
Section No. 3 Bill No. 2 Roads and Parking CONSTRUCTION OF NEW MANKWENG TRADITIONAL COUNCIL OFFICE FOR COGHSTA				

Section No. 3

Bill No. 2

Roads and Parking

COLLECTION

Total Brought Forward from Page No.

**Page
No**

82

83

Amount

Carried Forward to Summary of Section No. 3

R

Section No. 3

Bill No. 2

Roads and Parking

**CONSTRUCTION OF NEW MANKWENG TRADITIONAL COUNCIL OFFICE
FOR COGHSTA**

Item No	SECTION No. 3BILL No. 3	Quantity	Rate	Amount
	<u>FENCING AND GATES</u>			
	<u>PREAMBLES</u>			
	For Preambles see "Model of Preambles For Trades"			
	<u>Reinforced Pre cast concrete palisade fence, finished smooth on exposed surfaces, including site clearance and preparation of ground.</u>			
1	Palisade fence 3.0m high above ground level over flat terrain with 80mm tapering to 220mm x 3m long intermediate and end posts at centres cast into concrete bases, 145 x 80mm x 2m long top and bottom horizontal rails at intersections, including stopping off bolt holes with cement holes	m	400	
	<u>Gates</u>			
2	Galvanised mild steel sliding gate size 5,500mm wide x 3,000mm high overall comprising 2mm thick x 76mm wide x 50mm hollow section frame and running on 50 x 50 x 2mm thick angle section track embedded into and including 400mm wide x 600mm deep 25Mpa concrete ground beam and excavations for the same, filling, carting away of excess excavated material,etc	No	1	
3	Galvanised mild steel Pedestrian gate size 1,200 mm wide x 3,000mm high overall comprising 2mm thick x 76mm wide x 50mm hollow section frame and running on 50 x 50 x 2mm thick angle section track embedded into and including 400mm wide x 600mm deep 25Mpa concrete ground beam and excavations for the same, filling, carting away of excess excavated material,etc	No	1	
	Carried Forward to Summary of Section No. 3			R
	Section No. 3 Bill No. 3 Fencing and gates			
	CONSTRUCTION OF NEW MANKWENG TRADITIONAL COUNCIL OFFICE FOR COGHSTA			

SECTION SUMMARY - EXTERNAL WORKS

Bill No		Page No	Amount
1	Platforms	81	
2	Roads and Parking	84	
3	Fencing and gates	85	
Carried to Final Summary			R
Section No. 3 CONSTRUCTION OF NEW MANKWENG TRADITIONAL COUNCIL OFFICE FOR COGHSTA			

Item No		Unit	Quantity	Rate	Amount
	<u>SECTION No. 4 BILL No. 1</u>				
	<u>PROVISIONAL SUMS</u>				
	<u>PREAMBLES</u>				
	For Preambles see "Model Preambles For Trades,2008"				
	<u>ELECTRICAL WORKS</u>				
1	Provide the sum of R 1,850 000.00 (One million eight hundred and fifty thousand Rand) for the supply and installation of Electrical Works and Solar.		Item		1 850 000.00
2	Add for profit upon above, if required.		Item		
3	Add for attendance		Item		
	<u>MECHANICAL WORKS</u>				
4	Provide an amount of R400,000.00(Four hundred thousand Rand) for the installation of Mechanical Works including Fire detectors		Item		400 000.00
5	Add for profit upon above, if required		Item		
6	Add for attendance		Item		
	<u>BORE HOLE</u>				
7	Provide the sum of R 200 000.00 (Two Hundred Thousand rand) for the drilling of a Bore Hole including equipping, supply and installation of a 5000 litre "Jojo" or equally approved Tank and a 6m "Jojo" or equally approved Steel Stand including pipe connection to the building and a pressure pump secured in a suitable steel cage complete.		Item		200 000.00
8	Add for profit upon above, if required.		Item		
9	Add for attendance		Item		
	Carried to Collection			R	
	Section No. 4 Bill No. 1 Provisional Sums				
	CONSTRUCTION OF NEW MANKWENG TRADITIONAL COUNCIL OFFICE FOR COGHSTA				

GEOHYDROLOGICAL SURVEY

10	Provide the sum of R50 000.00(Fifty Thousand rand) for Geohydrological survey and the production of borehole reports.	Item	50 000.00
11	Add for profit upon above, if required	Item	
12	Add for attendance	Item	

JOINERY FITTINGS

13	Provide the sum of R 150 000-00 (One Hundred and Fifty thousand Rand) for the supply, delivery and installation of Joinery Fittings including Granite tops (Kitchen Unit, Fixed Benches, etc) complete.	Item	150 000.00
14	Add for profit upon above, if required.	Item	
15	Add for attendance	Item	

SIGNAGE

16	Provide the sum of R 30 000-00 (Thirty thousand rand) for supply and installation signage complete	Item	30 000.00
17	Add for profit upon above, if required.	Item	
18	Add for attendance	Item	

OCCUPATIONAL HEALTH AND SAFETY CONSULTANT

19	Provide the sum of R360 000-00(Three Hundred Sixty Thousand Rand) for Occupational health and safety consultant to be appointed by the Employer	Item	360 000.00
20	Add for profit upon above, if required	Item	
21	Add for attendance	Item	

SOCIAL FACILITATOR

22	Provide the sum of R300 000-00(Three Hundred Thousand Rand) for Social Facilitator to be appointed by the Employer	Item	300 000.00
----	--	------	------------

Carried to Collection

R

Section No. 4

Bill No. 1

Provisional Sums

CONSTRUCTION OF NEW MANKWENG TRADITIONAL COUNCIL OFFICE FOR COGHSTA

23	Add for profit upon above, if required	Item	
24	Add for attendance	Item	
<u>COMMUNITY LAISON OFFICER</u>			
25	Provide the sum of R 72 000-00 (Seventy two thousand rand) for remuneration	Item	72 000.00
26	Add for profit upon above, if required.	Item	
27	Add for attendance	Item	
<u>PROJECT STEERING COMMITTEE</u>			
28	Provide the sum of R 12 000-00 (Twelve thousand Rand) for remuneration	Item	12 000.00
29	Add for profit upon above, if required.	Item	
30	Add for attendance	Item	
Carried to Collection			
Section No. 4			
Bill No. 1			
Provisional Sums			
CONSTRUCTION OF NEW MANKWENG TRADITIONAL COUNCIL OFFICE FOR COGHSTA			
			R

Section No. 4

Bill No. 1

Provisional Sums

COLLECTION

Total Brought Forward from Page No.

**Page
No**

Amount

87

88

89

Carried to Final Summary

R

Section No. 4

Bill No. 1

Provisional Sums

**CONSTRUCTION OF NEW MANKWENG TRADITIONAL COUNCIL OFFICE
FOR COGHSTA**

Section No	FINAL SUMMARY	Page No	Amount
1	PRELIMINARIES	32	
2	BUILDING WORK	78	
3	EXTERNAL WORKS	86	
4	PROVISIONAL SUMS	90	
	Sub-total		R
	<u>Contingencies</u>		
	Allow an Amount of R 400 000.00 (Four hundred Thousand) for contingencies to be used as directed by the Project Manager and to be deducted in full if not used.	Item	400 000.00
	Sub-total		R
	<u>Value Added Tax</u>		
	Allow for Value Added Tax (15%)		R
	CARRIED TO FORM OF TENDER		R
	CONSTRUCTION OF NEW MANKWENG TRADITIONAL COUNCIL OFFICE FOR COGHSTA		

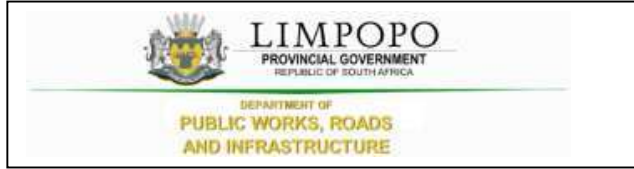

PART C3 SCOPE OF WORKS

Bidder's initials

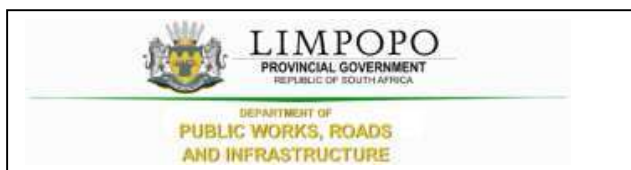

PART C3.1: SPECIAL NOTES TO BIDDERS

The following special conditions are for compliance and attention to bidders:

- 1.1. LDPWRI reserve the right to call interviews with short-listed bidders before final selection.
- 1.2. LDPWRI reserve the right to conduct supplier due diligence prior to final award or at any time during the contract period. This may include surprise site visits.
- 1.3. LDPWRI reserve the right to appoint the bidder that proves to be fully capable and qualified to handle and execute the job.
- 1.4. The proposals submitted must be in line with the detailed specification.
- 1.5. LDPWRI reserve the right to cancel or withdraw this bid if:
 - i. Due to changed circumstances, there is no longer a need for this services; or
 - ii. Funds are no longer available to cover the total envisaged expenditure; or
 - iii. No acceptable bids are received; or
 - iv. There is a material irregularity in the Bid process.
- 1.6. In the case of sub-contracting or joint venture agreement, LDPWRI will enter into a single contract with the principal bidder.
- 1.7. Bidders who are not registered on Central Supplier Database (CSD) must register before submission of bids.
- 1.8. Any completion of the bid document in pencil or erasable ink will not be acceptable and will automatically disqualify the submitted bid.
- 1.9. Successful bidder will be required to sign and enter into a formal contract upon the award.
- 1.10. Notwithstanding shortcomings and/or inconsistencies, if any, in this specification, which is only a minimum specification, a bidder shall make provision for a complete solution that will deliver the required service efficiently and cost-effectively.
- 1.11. Bid documents must be submitted physically to the closing address as reflected on the Request for Quotations.
- 1.12. Quotations received after the closing date and time will not be accepted for consideration.
- 1.13. This request for bid document contains confidential information about LDPWRI, which has been provided to supply potential bidders with the data necessary to provide a holistic response.
- 1.14. No part of the contents may be used, copied, disclosed or conveyed in whole or in part to any party, in any manner whatsoever without the prior written permission of LDPWRI.
- 1.15. Any reproduction or transmission of information contained in this document except for the sole purpose of responding to this bid is strictly prohibited.

References to LDPWRI must not be made in any literature, promotional material, and brochures or sales presentations without the express written consent of LDPWRI

Bidder's initials

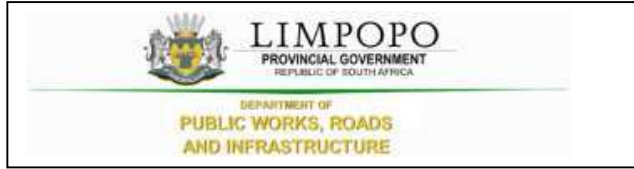

PART C3.2: OHS SPECIFICATIONS

Bidder's initials

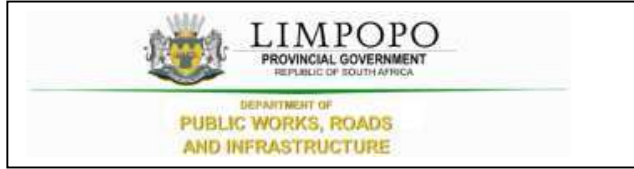

PART C4 SITE INFORMATION

Bidder's initials

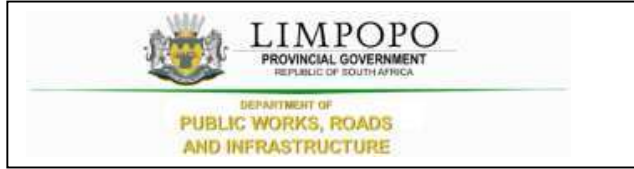

C4.1 DRAWINGS

Bidder's initials

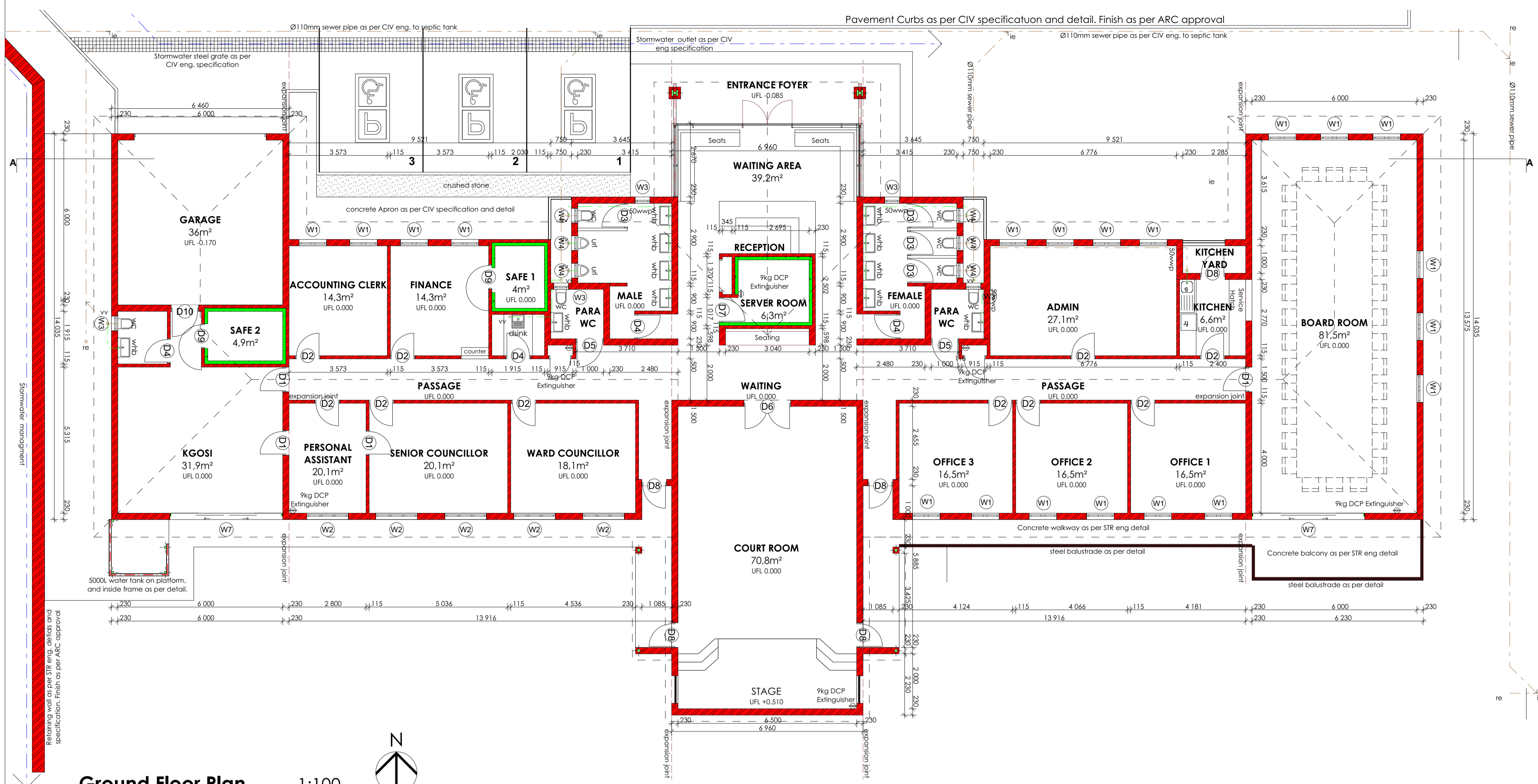

COPYRIGHT
In accordance with the relevant clauses of the Copyright Act (Act 98 of 1978) relating to assignment, all documents prepared by DPWL in connection with the project remain the property and copyright of DPWL, subject to their use by the client for the particular project to which this document relates, and the client shall not be entitled, either directly or indirectly, to make use of the document(s) for any additional or similar works or publish the same except with the prior consent from DPWL.

- GENERAL NOTES**
- All general notes apply to all drawings, details, specifications & any supplementary information: all contractual documentation.
 - The contractor is responsible for checking all levels & dimensions on site when setting out, prior to commencing construction & cross checking all building dimensions during the construction process. Read only figured dimensions, indicated in millimetres, & do not scale. Any discrepancies are to be reported in writing to DPWL prior to continuation of work.
 - The contractor is responsible for the works co-ordination & programming of the works. All consultant & shop drawings are to be cross checked with DPWL drawings. Any discrepancies are to be reported in writing to DPWL prior to continuation of work.
 - The contractor is responsible for reporting any deviation from DPWL drawings & specifications. Written approval is required from edifice design prior to construction & installation commencing.
 - DPWL accepts no responsibility for errors resulting from the misinterpretation of drawings or specifications, if in doubt, query details.
 - The contractor is responsible for compliance with all applicable SABS 0400 standards, manufacturer's installation instructions, procedures & recommendations & local authority regulations in respect of the full scope of the works. This requirement shall not be deemed to be superseded by the provisions of any other contract document.
 - The contractor is responsible for construction procedures & methodology being carried out & implemented in strict accordance with the latest occupational health & safety act & regulations.
 - The contractor is responsible for checking all opening sizes & vertical & horizontal position prior to the construction, manufacture & installation of fitted items. Any discrepancies are to be reported in writing to DPWL prior to continuation of work.
 - The contractor is responsible for the provision of guarantees for all materials, installations & systems, to be issued to DPWL at practical completion.
 - All structural work is to be designed, detailed, specified & supervised by the structural engineer & is to be carried out in strict accordance with this. All structural work is to be built from the engineer's drawings and the stability is to be certified by the structural engineer on completion of the works.
 - Drawings are only to be read for the purpose intended.
 - Refer to project data sheet for comprehensive notes & specifications.

DOOR AND WINDOWS:
Windows glazing to be in accordance with NBR. Bathroom and WC windows to be obscure.

GLAZING:
All Glazing unless specified Clear laminated sound control safety glass, complying with SANS 1263 Part 1, 2 or 3 with name of the manufacturer permanently marked on each sheet visible after glazing, glazed in accordance with NBR N schedule 1 and SABS 0137.

Glass Properties:
• Shading Coefficient = 0.47 to 0.70
• Light Transmission Level = 61 to 95

Specified: Obscure glazed unit, glazed in accordance with NBR N schedule 1 and SABS 0137.

Glass Properties:
• Shading Coefficient = 0.58 to 0.75
• Light Transmission Level = 59 to 83

EXTERNAL WORKS:
All Paving to be laid on well compacted AND consolidated ground to engineer's detail. Soil panning shall be provided under paving in accordance to Engineer's specifications.

CONCRETE:
All proposed and existing concrete works, paving AND storm water reticulation to be specified, verified and approved by engineer.

PLASTER:
Internal plaster to be 10 to 15mm thick, cement / sand ratio of 1:5 plaster sealed, 1 undercoat, 2 coats 'wall n all' paint. Colour to be approved.

EXPANSION JOINTS:
Expansion (control) joints where deemed necessary by engineer to be formed with a continuous strip of 12mm bitumen impregnated felt-board between 230mm brick walls. To be sealed internally and externally with 10mm deep polysulphide sealant.

INSULATION:
50mm Alutherm AP polyester fibre blanket laminated to 4mm White bubble layer on one side and reinforced foil facing on other, complying with SANS 1381-1:2007, laid and stapled horizontally on top of timber rafters and branding before fixing of roof sheeting (elsewhere specified).

REV NO.	DATE	REVISION

DEPARTMENT
LIMPOPO
PROVINCIAL GOVERNMENT
REPUBLIC OF SOUTH AFRICA
DEPARTMENT OF
PUBLIC WORKS, ROADS & INFRASTRUCTURE
Limpopo Department of Public Works, Roads and Infrastructure's Strategic Planning and Design Hub.
43 Church Street, Polokwane, 0700
(015) 284 7000/1

PROJECT TITLE
TRIBAL OFFICE FOR THE DEPARTMENT OF TRADITIONAL AFFAIRS

DRAWING TITLE
OFFICE: PLAN & ELEVATIONS

SCALE	1:100	DRAWN	T.CELE
DATE		CHECKED	T.CELE

SIZE	PROJECT NO.	STAGE	DRAWING NO.	REV.
A1	LDPWRI B/17020	C	LDPWRI B/17020-100	0

FOR CONSTRUCTION

COPYRIGHT
 In accordance with the relevant clauses of the Copyright Act (Act 98 of 1978) relating to assignment, all documents prepared by DPWL in connection with the project remain the property and copyright of DPWL, subject to their use by the client for the particular project to which this document relates, and the client shall not be entitled, either directly or indirectly, to make use of the document[s] for any additional or similar works or publish the same except with the prior consent from DPWL.

- GENERAL NOTES**
- All general notes apply to all drawings, details, specifications & any supplementary information: all contractual documentation.
 - The contractor is responsible for checking all levels & dimensions on site when setting out, prior to commencing construction & cross checking all building dimensions during the construction process. Read only figured dimensions, indicated in millimetres, & do not scale. Any discrepancies are to be reported in writing to DPWL prior to continuation of work.
 - The contractor is responsible for the works co-ordination & programming of the works. All consultant & shop drawings are to be cross checked with DPWL drawings. Any discrepancies are to be reported in writing to DPWL prior to continuation of work.
 - The contractor is responsible for reporting any deviation from DPWL drawings & specifications. Written approval is required from edifice design prior to construction & installation commencing.
 - DPWL accepts no responsibility for errors resulting from the misinterpretation of drawings or specifications. If in doubt, query details.
 - The contractor is responsible for compliance with all applicable SABS 0400 standards, manufacturer's installation instructions, procedures & recommendations & local authority regulations in respect of the full scope of the works. This requirement shall not be deemed to be superseded by the provisions of any other contract document.
 - The contractor is responsible for construction procedures & methodology being carried out & implemented in strict accordance with the latest occupational health & safety act & regulations.
 - The contractor is responsible for checking all opening sizes & vertical & horizontal position prior to the construction, manufacture & installation of fitted items. Any discrepancies are to be reported in writing to DPWL prior to continuation of work.
 - The contractor is responsible for the provision of guarantees for all materials, installations & systems, to be issued to DPWL at practical completion.
 - All structural work is to be designed, detailed, specified & supervised by the structural engineer & is to be carried out in strict accordance with this. All structural work is to be built from the engineer's drawings and the stability is to be certified by the structural engineer on completion of the works.
 - Drawings are only to be read for the purpose intended.
 - Refer to project data sheet for comprehensive notes & specifications.

DOOR AND WINDOWS:
 Windows glazing to be in accordance with NBR. Bathroom and WC windows to be obscure.

GLAZING:
 All Glazing unless specified Clear laminated sound control safety glass, complying with SANS 1263 Part 1, 2 or 3 with name of the manufacturer permanently marked on each sheet visible after glazing, glazed in accordance with NBR N schedule 1 and SABS 0137.

Glass Properties:
 • Shading Coefficient = 0.47 to 0.70
 • Light Transmission Level = 61 to 95

Specified: Obscure glazed unit, glazed in accordance with NBR N schedule 1 and SABS 0137.

Glass Properties:
 • Shading Coefficient = 0.58 to 0.75
 • Light Transmission Level = 59 to 83

EXTERNAL WORKS:
 ALL Paving to be laid on well compacted AND consolidated ground to engineer's detail. Soil piling shall be provided under paving in accordance to Engineer's specifications.

CONCRETE:
 All proposed and existing concrete works, paving AND storm water reticulation to be specified, verified and approved by engineer.

PLASTER:
 Internal plaster to be 10 to 15mm thick, cement / sand ratio of 1:5 plaster sealed, 1 undercoat, 2 coats 'wall n all' paint. Colour to be approved.

EXPANSION JOINTS:
 Expansion (control) joints where deemed necessary by engineer to be formed with a continuous strip of 12mm bitumen impregnated soft-board between 230mm brick walls, to be sealed internally and externally with 10mm deep polysulphide sealant.

INSULATION:
 50mm Alutherm AP polyester fibre blanket laminated to 4mm White bubble layer on one side and reinforced foil facing on other, complying with SANS 1381-1:2007, laid and stapled horizontally on top of timber rafters and branding before fixing of roof sheeting (elsewhere specified).

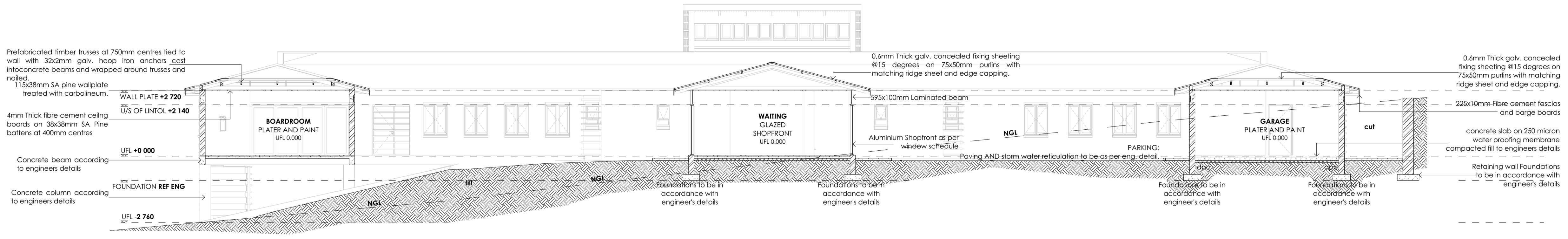

SECTION A-A 1:100

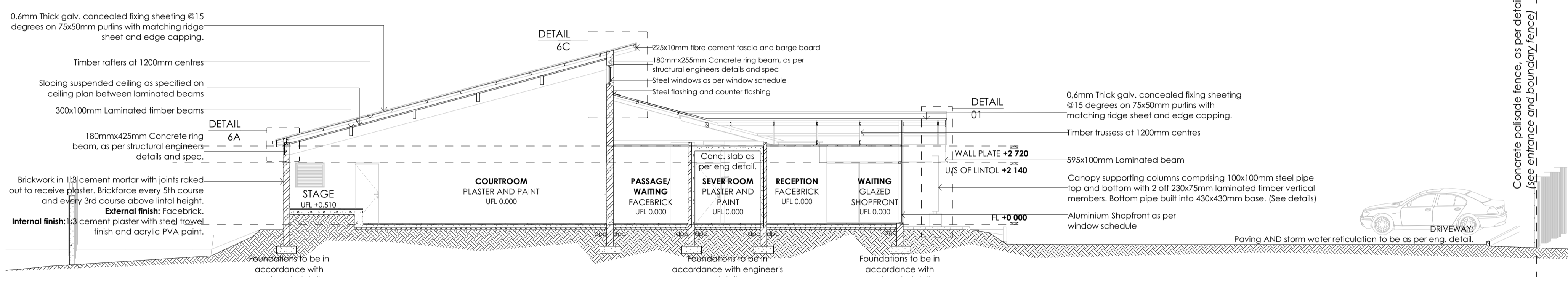

SECTION B-B 1:100

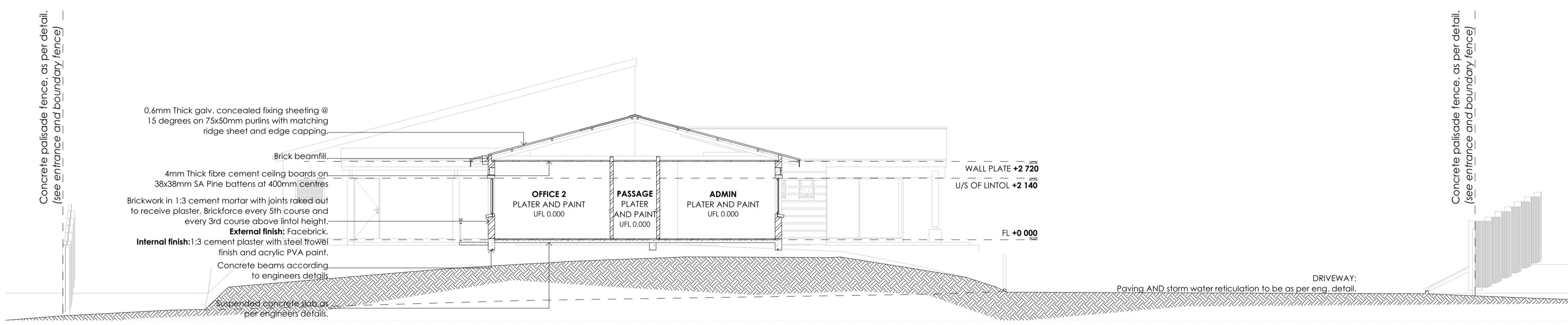

SECTION C-C 1:100

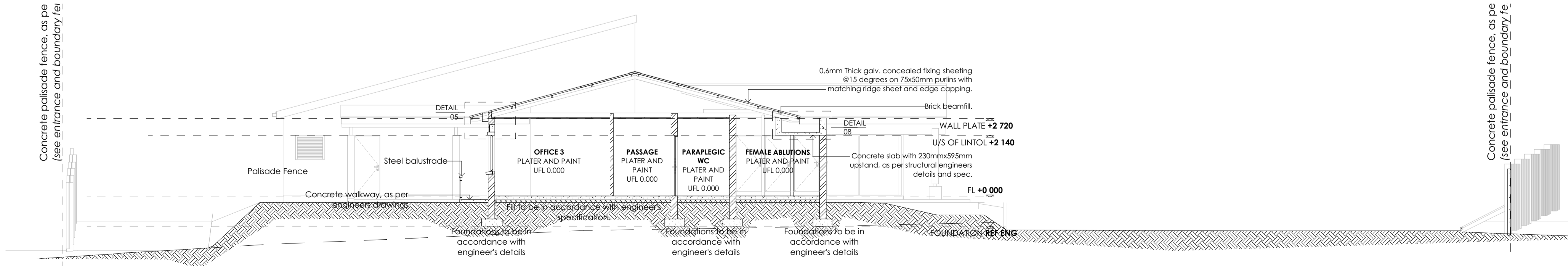

SECTION D-D 1:100

REV NO.	DATE	REVISION

DEPARTMENT

 DEPARTMENT OF
PUBLIC WORKS, ROADS & INFRASTRUCTURE
 Limpopo Department of Public Works, Roads and Infrastructure's Strategic Planning and Design Hub.
 43 Church Street, Polokwane, 0700
 (015) 284 7000/1

PROJECT TITLE
 TRIBAL OFFICE FOR THE DEPARTMENT OF TRADITIONAL AFFAIRS

DRAWING TITLE
 OFFICE: SECTIONS

SCALE	1:100	DRAWN	T.CELE
DATE		CHECKED	T.CELE

SIZE	PROJECT NO.	STAGE	DRAWING NO.	REV.
A1	LDPWRI B/17020	C	LDPWRI B/17020_100	0

FOR CONSTRUCTION

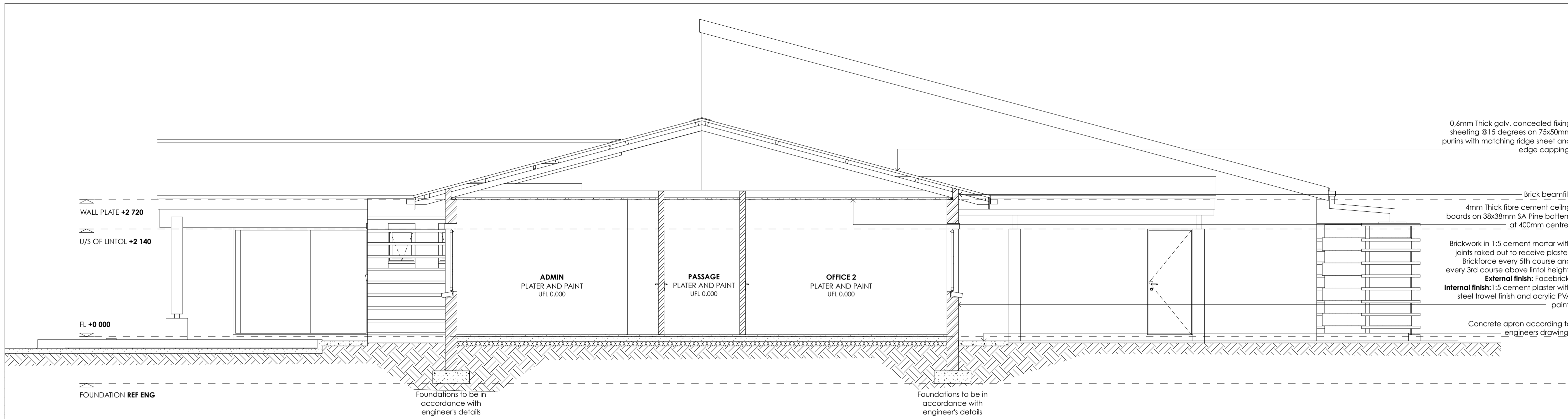

SECTION C-C 1:50

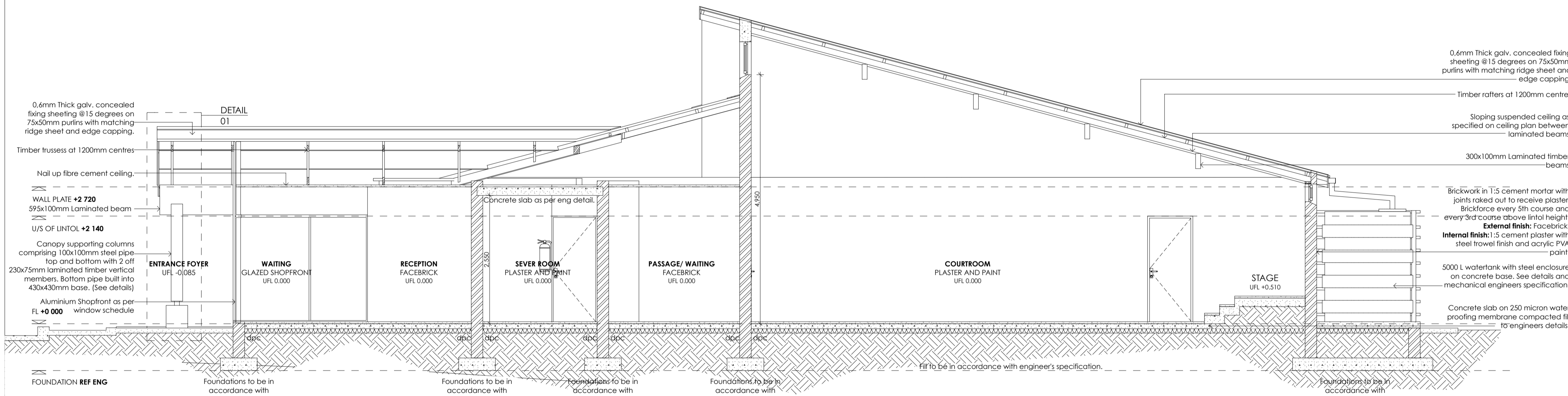

SECTION B-B 1:50

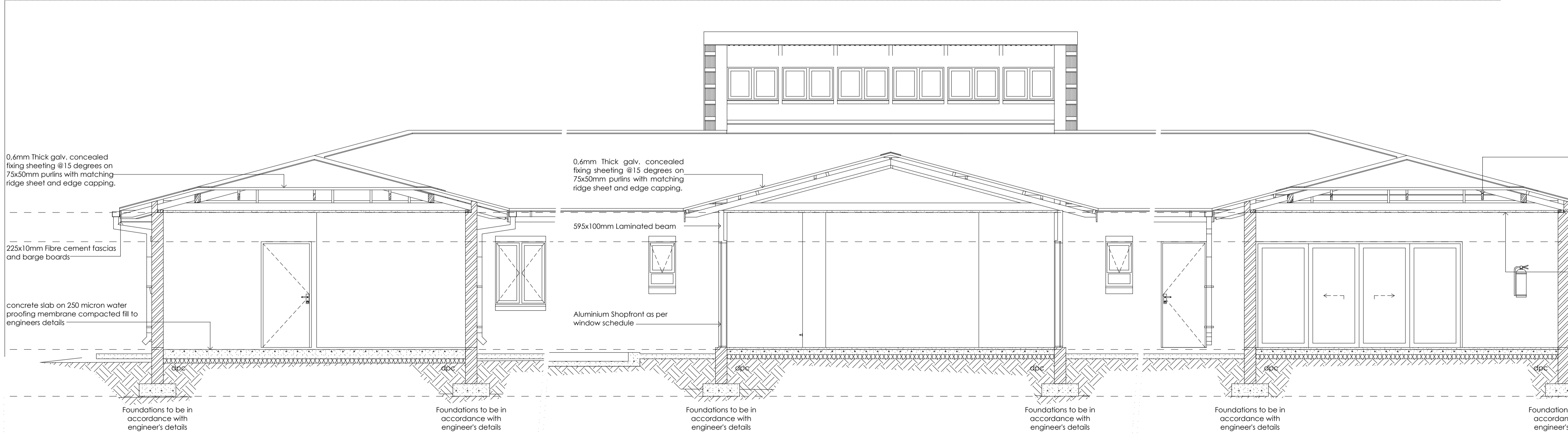

SECTION A-A 1:50

- GENERAL NOTES**
- All general notes apply to all drawings, details, specifications & any supplementary information; all contractual documentation.
 - The contractor is responsible for checking all levels & dimensions on site when setting out, prior to commencing construction & cross checking all building dimensions during the construction process. Read only figured dimensions, indicated in millimetres, & do not scale. Any discrepancies are to be reported in writing to DPWL prior to continuation of work.
 - The contractor is responsible for the works co-ordination & programming of the works. All consultant & shop drawings are to be cross checked with DPWL drawings. Any discrepancies are to be reported in writing to DPWL prior to continuation of work.
 - The contractor is responsible for reporting any deviation from DPWL drawings & specifications. Written approval is required from edifice design prior to construction & installation commencing.
 - DPWL accepts no responsibility for errors resulting from the misinterpretation of drawings or specifications. If in doubt, query details.
 - The contractor is responsible for: compliance with all applicable SABS 0400 standards, manufacturer's installation instructions, procedures & recommendations & local authority regulations in respect of the full scope of the works. This requirement shall not be deemed to be superseded by the provisions of any other contract document.
 - The contractor is responsible for construction procedures & methodology being carried out & implemented in strict accordance with the latest occupational health & safety act & regulations.
 - The contractor is responsible for checking all opening sizes & vertical & horizontal position prior to the construction, manufacture & installation of fitted items. Any discrepancies are to be reported in writing to DPWL prior to continuation of work.
 - The contractor is responsible for the provision of guarantees for all materials, installations & systems, to be issued to DPWL at practical completion.
 - All structural work is to be designed, detailed, specified & supervised by the structural engineer & is to be carried out in strict accordance with this. All structural work is to be built from the engineer's drawings and the stability is to be certified by the structural engineer on completion of the works.
 - Drawings are only to be read for the purpose intended.
 - Refer to project data sheet for comprehensive notes & specifications.

DOOR AND WINDOWS:
All external doors and windows to have aluminium frames as per SABS specifications. Internal doors to be flush panel semi-solid with hardwood frames provided with one pair 100mm brass butt hinges and lock set. Windows glazing to be in accordance with NBR. Bathroom and WC windows to be obscure.

GLAZING:
All Glazing unless specified Clear laminated sound control safety glass, complying with SANS 1263 Part 1, 2 or 3 with name of the manufacturer permanently marked on each sheet visible after glazing, glazed in accordance with NBR N schedule 1 and SABS 0137.

Glass Properties:
• Shading Coefficient = 0.47 to 0.70
• Light Transmission Level = 61 to 95

Specified: Obscure glazed unit, glazed in accordance with NBR N schedule 1 and SABS 0137.

Glass Properties:
• Shading Coefficient = 0.58 to 0.75
• Light Transmission Level = 59 to 83

EXTERNAL WORKS:
ALL Paving to be laid on well compacted AND consolidated ground to engineer's detail. Soil poisoning shall be provided under paving in accordance to Engineer's specifications.

CONCRETE:
All proposed and existing concrete works, paving AND storm water reticulation to be specified, verified and approved by engineer.

PLASTER:
Internal plaster to be 10 to 15mm thick, cement /sand ratio of 1:5 plaster sealed, 1 undercoat, 2 coats 'wall n all' paint. Colour to be approved.

EXPANSION JOINTS:
Expansion (control) joints where deemed necessary by engineer to be formed with a continuous strip of 12mm bitumen impregnated soft-board between 230mm brick walls. To be sealed internally and externally with 10mm deep polysulphide sealant.

INSULATION:
50mm Alutherm AP polyester fibre blanket laminated to 4mm white bubble layer on one side and reinforced foil facing on other, complying with SANS 1381-1:2007, laid and stapled horizontally on top of timber rafters and bracing before fixing of roof sheeting (elsewhere specified).

Prefabricated timber trusses at 750mm centres tied to wall with 32x2mm galv. hoop iron anchors cast into concrete beams and wrapped around trusses and nailed.

0,6mm Thick galv. concealed fixing sheeting @ 15 degrees on 75x50mm purlins with matching ridge sheet and edge capping.

115x38mm SA pine wallplate treated with carbolineum.

WALL PLATE +2 720

U/S OF LINTOL +2 140

4mm Thick fibre cement ceiling boards on 38x38mm SA Pine battens at 400mm centres

Concrete apron according to engineers drawings

FOUNDATION REF ENG

COPYRIGHT
In accordance with the relevant clauses of the Copyright Act (Act 98 of 1978) relating to assignment, all documents prepared by DPWL in connection with the project remain the property and copyright of DPWL, subject to their use by the client for the particular project to which this document relates, and the client shall not be entitled, either directly or indirectly, to make use of the document(s) for any additional or similar works or publish the same except with the prior consent from DPWL.

REV NO.	DATE	REVISION

DEPARTMENT

LIMPOPO
PROVINCIAL GOVERNMENT
REPUBLIC OF SOUTH AFRICA

DEPARTMENT OF
PUBLIC WORKS, ROADS & INFRASTRUCTURE

Limpopo Department of Public Works, Roads and Infrastructure's Strategic Planning and Design Hub.
43 Church Street, Polokwane, 0700
(015) 284 7000/1

PROJECT TITLE
MASIA: TRIBAL OFFICE FOR THE DEPARTMENT OF TRADITIONAL AFFAIRS

DRAWING TITLE
OFFICE: SECTIONS

SCALE	1:100	DRAWN	T.CELE
DATE	14_08_2018	CHECKED	T.CELE

SIZE	PROJECT NO.	STAGE	DRAWING NO.	REV.
A1	TO_19000	C	TO_19000_102	0

FOR CONSTRUCTION

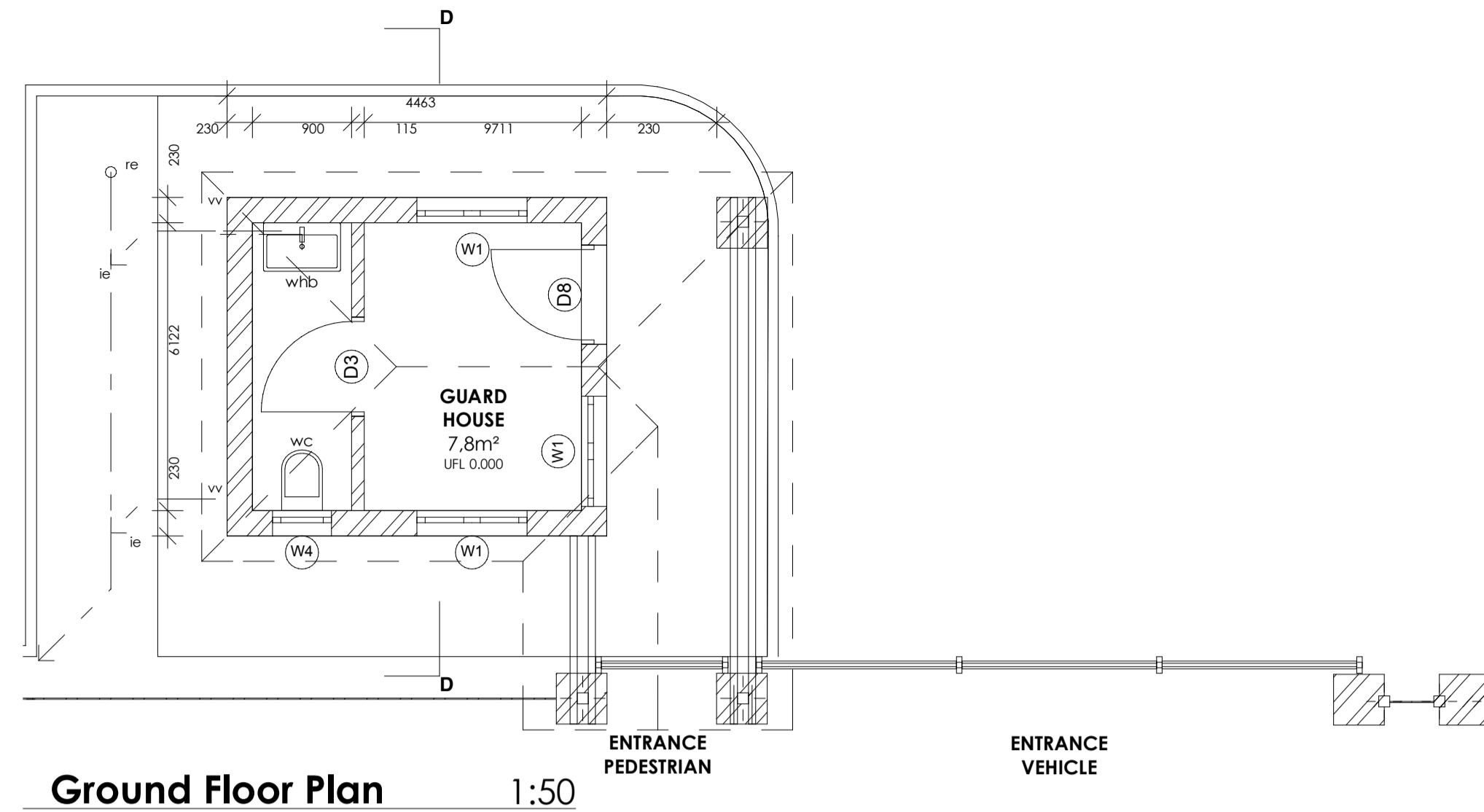

Ground Floor Plan 1:50

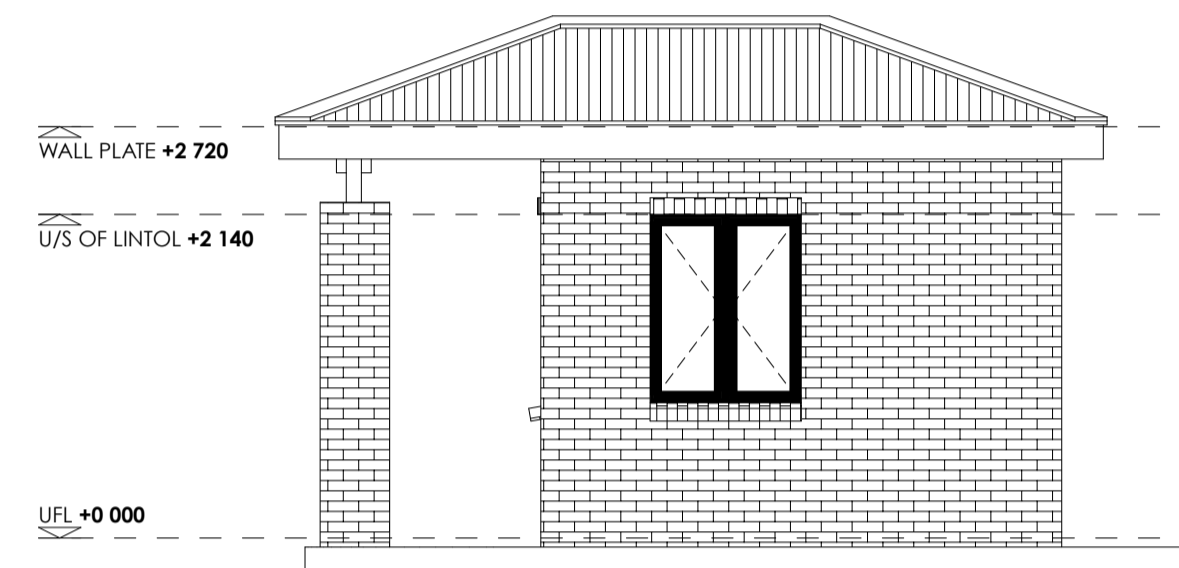

North East Elevation 1:50

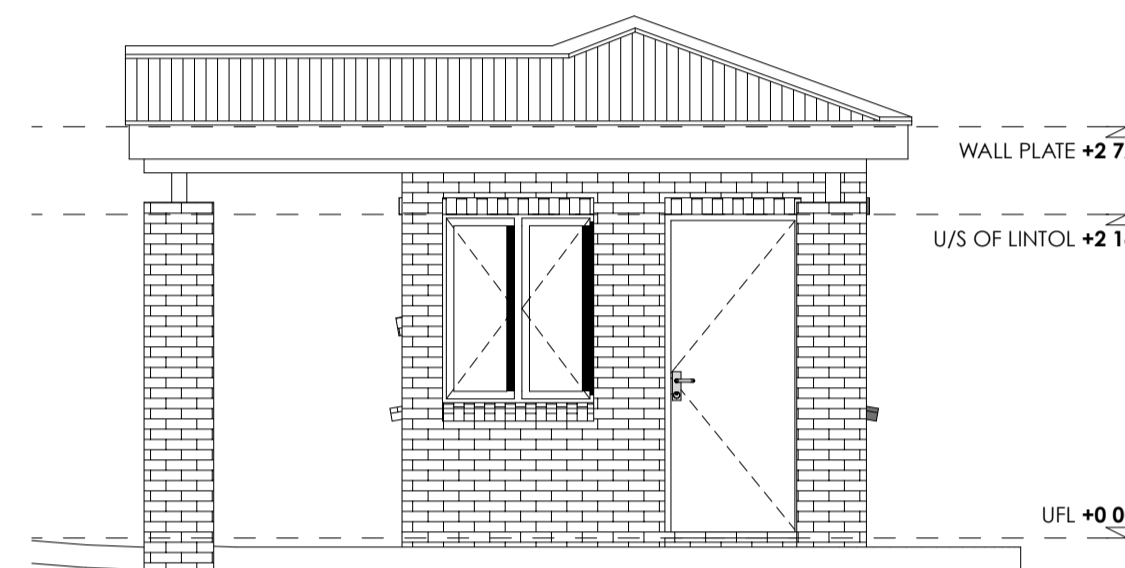

South East Elevation 1:50

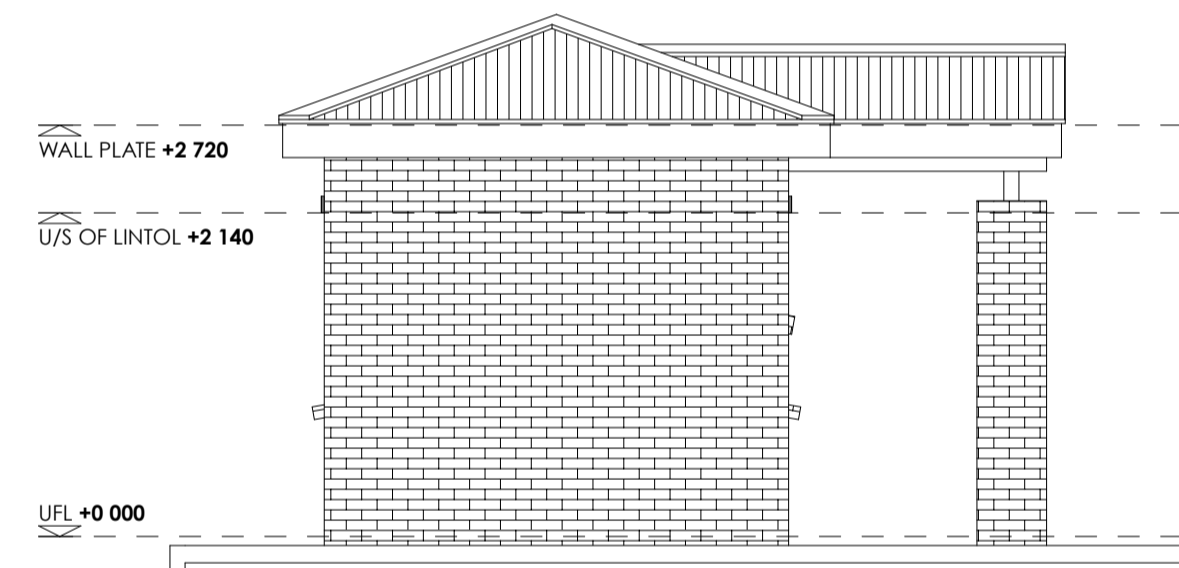

North West Elevation 1:50

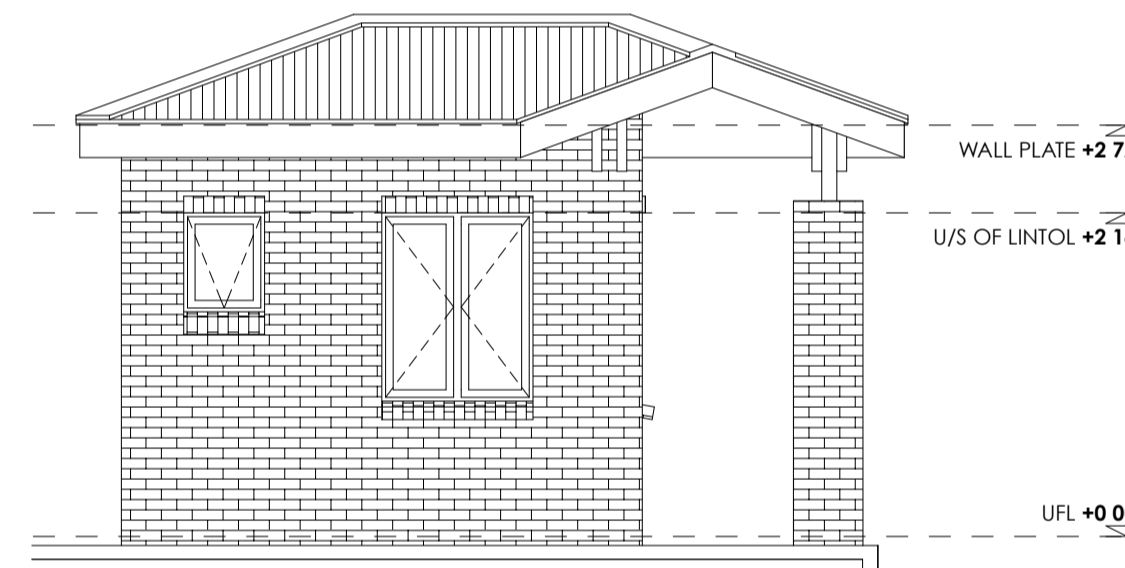

South West Elevation 1:50

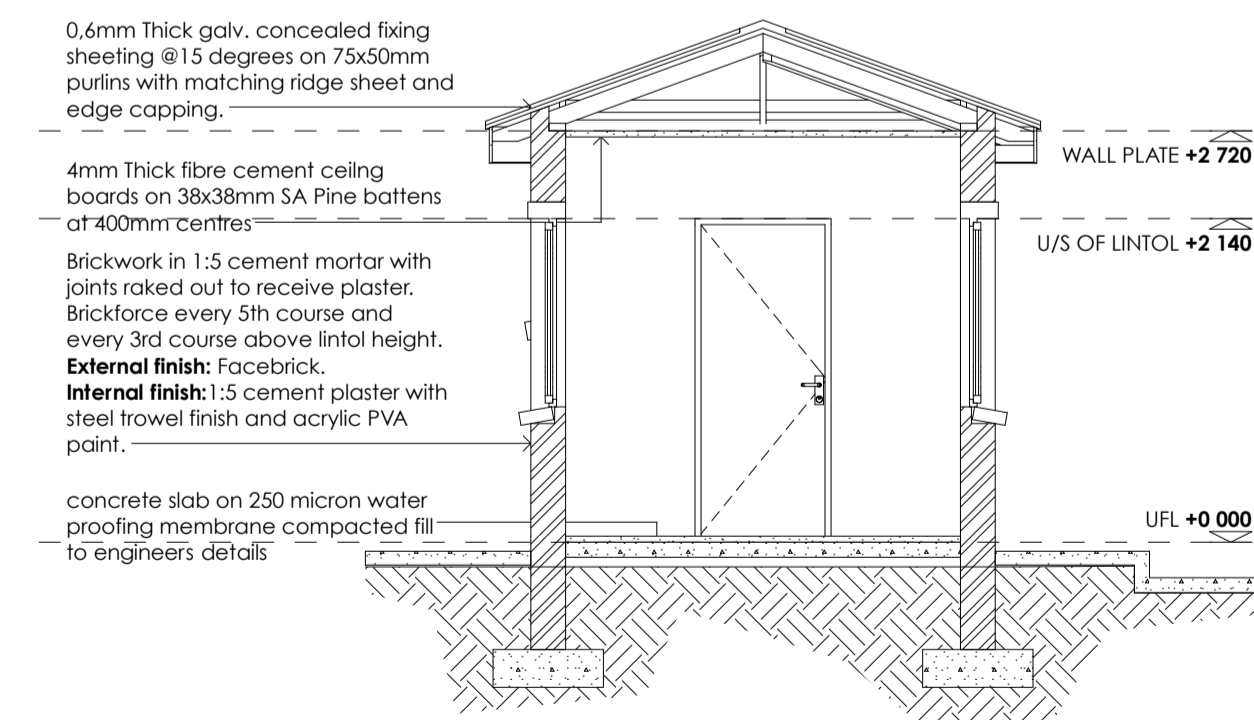

Section D-D 1:50

0,6mm Thick galv. concealed fixing sheeting @ 15 degrees on 75x30mm purlins with matching ridge sheet and edge copping.

4mm Thick fibre cement ceiling boards on 38x38mm SA Pine battens at 400mm centres

Brickwork in 1:5 cement mortar with joints raked out to receive plaster. Brickforce every 5th course and every 3rd course above lintol height. External finish: Facebrick. Internal finish: 1:5 cement plaster with steel towel finish and acrylic PVA paint.

concrete slab on 250 micron water proofing membrane compacted fill to engineers details

GENERAL NOTES

- All general notes apply to all drawings, details, specifications & any supplementary information; all contractual documentation.
- The contractor is responsible for checking all levels & dimensions on site when setting out, prior to commencing construction & cross checking all building dimensions during the construction process. Read only figured dimensions, indicated in millimetres, & do not scale. Any discrepancies are to be reported in writing to DPWL prior to continuation of work.
- The contractor is responsible for the works co-ordination & programming of the works. All consultant & shop drawings are to be cross checked with DPWL drawings. Any discrepancies are to be reported in writing to DPWL prior to continuation of work.
- The contractor is responsible for reporting any deviation from DPWL drawings & specifications. Written approval is required from edifice design prior to construction & installation commencing.
- DPWL accepts no responsibility for errors resulting from the misinterpretation of drawings or specifications. If in doubt, query details.
- The contractor is responsible for; compliance with all applicable SABS 0400 standards, manufacturer's installation instructions, procedures & recommendations & local authority regulations in respect of the full scope of the works. This requirement shall not be deemed to be superseded by the provisions of any other contract document.
- The contractor is responsible for construction procedures & methodology being carried out & implemented in strict accordance with the latest occupational health & safety act & regulations.
- The contractor is responsible for checking all opening sizes & vertical & horizontal position prior to the construction, manufacture & installation of fitted items. Any discrepancies are to be reported in writing to DPWL prior to continuation of work.
- The contractor is responsible for the provision of guarantees for all materials, installations & systems, to be issued to DPWL at practical completion.
- All structural work is to be designed, detailed, specified & supervised by the structural engineer & is to be carried out in strict accordance with this. All structural work is to be built from the engineer's drawings and the stability is to be certified by the structural engineer on completion of the works.
- Drawings are only to be read for the purpose intended.
- Refer to project data sheet for comprehensive notes & specifications.

DOOR AND WINDOWS:

All external doors and windows to have aluminium frames as per SABS specifications. Internal doors to be flush panel semi-solid with hardwood frames provided with one pair 100mm brass butt hinges and lock set. Windows glazing to be in accordance with NBR. Bathroom and WC windows to be obscure.

GLAZING:

All Glazing unless specified Clear laminated sound control safety glass, complying with SANS 1263 Part 1, 2 or 3 with name of the manufacturer permanently marked on each sheet visible after glazing, glazed in accordance with NBR N schedule 1 and SABS 0137.

Glass Properties:
 • Shading Coefficient = 0.47 to 0.70
 • Light Transmission Level = 61 to 95

Specified: Obscure glazed unit, glazed in accordance with NBR N schedule 1 and SABS 0137.

Glass Properties:
 • Shading Coefficient = 0.58 to 0.75
 • Light Transmission Level = 59 to 83

EXTERNAL WORKS:

ALL Paving to be laid on well compacted AND consolidated ground to engineer's detail. Soil poisoning shall be provided under paving in accordance to Engineer's specifications.

CONCRETE:

All proposed and existing concrete works, paving AND storm water reticulation to be specified, verified and approved by engineer.

PLASTER:

Internal plaster to be 10 to 15mm thick, cement /sand ratio of 1:5 plaster sealed, 1 undercoat, 2 coats 'wall n all' paint. Colour to be approved.

EXPANSION JOINTS:

Expansion (control) joints where deemed necessary by engineer to be formed with a continuous strip of 12mm bitumen impregnated soft-board between 230mm brick walls. To be sealed internally and externally with 10mm deep polysulphide sealant.

INSULATION:

50mm AluTherm AP polyester fibre blanket laminated to 4mm White bubble layer on one side and reinforced foil facing on other, complying with SANS 1381-1:2007, laid and stapled horizontally on top of timber rafters and bracing before fixing of roof sheeting (elsewhere specified).

COPYRIGHT

In accordance with the relevant clauses of the Copyright Act (Act 98 of 1978) relating to assignment, all documents prepared by DPWL in connection with the project remain the property and copyright of DPWL, subject to their use by the client for the particular project to which this document relates, and the client shall not be entitled, either directly or indirectly, to make use of the document(s) for any additional or similar works or publish the same except with the prior consent from DPWL.

REV NO.	DATE	REVISION

DEPARTMENT

DEPARTMENT OF
PUBLIC WORKS, ROADS & INFRASTRUCTURE
 Limpopo Department of Public Works, Roads and Infrastructure's Strategic Planning and Design Hub.
 43 Church Street, Polokwane, 0700
 (015) 284 7000/1

PROJECT TITLE
 MASIA: TRIBAL OFFICE FOR THE DEPARTMENT OF TRADITIONAL AFFAIRS

DRAWING TITLE
 GUARD HOUSE

SCALE	1:100	DRAWN	T.CELE
DATE	14_08_2018	CHECKED	T.CELE

SIZE	PROJECT NO.	STAGE	DRAWING NO.	REV.
A1	TO_19000	C	TO_19000_104	0

FOR CONSTRUCTION

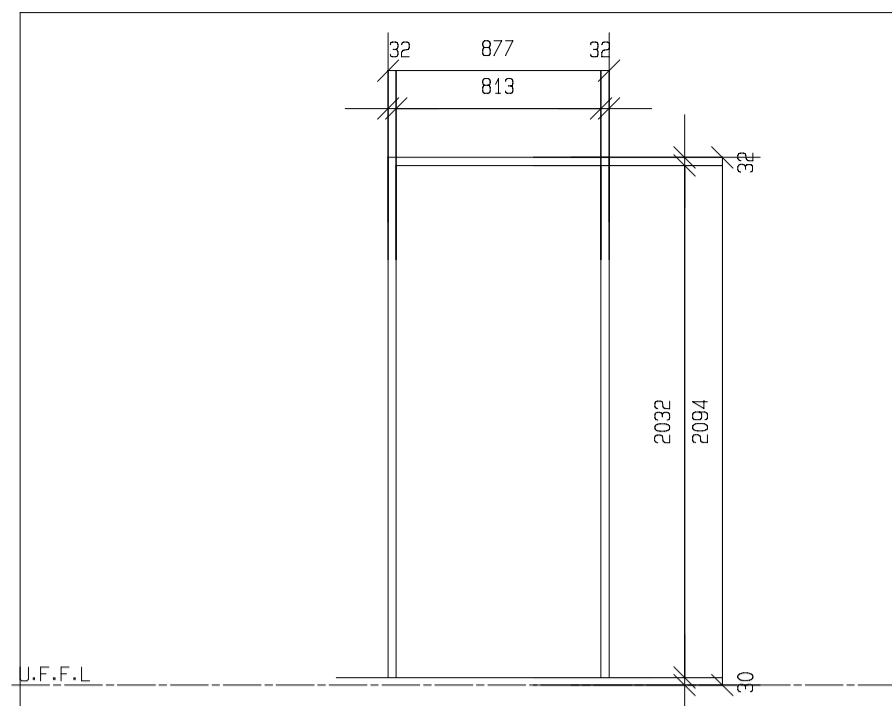

DOOR NO.	D1	NUMBER REQD.
FRAME DESCRIPTION	EXISTING STANDARD 1.2mm THICK SINGLE REBATE MILD STEEL DOOR FRAME COMPLETE WITH ONE PAIR STANDARD BUTT HINGES. FOR 115mm OR 230mm WALL.	
FRAME FINISHING	SAND DOWN EXISTING FRAME AND APPLY COATS POLYURETHANE ENAMEL. SANDPAPER LIGHTLY BETWEEN COATS. COLOUR ACC. TO ARCHITECT.	
DOOR DESCRIPTION	NEW 2032x813x40mm THICK SEMI-SOLID CORE DOOR WITH 3mm THICK TEMPERED HARDBOARD SIDES AND CONCEALED HARDWOOD EDGES.	
DOOR FINISHING	PREPARE AND CLEAN. APPLY ONE COAT WOOD PRIMER AND TWO COATS POLYURETHANE VELVET ENAMEL. SANDPAPER LIGHTLY BETWEEN COATS. COLOUR ACC. TO ARCHITECT.	
FANLIGHT	NONE.	
IRONMONGERY AND SUNDRIES	SEE SPECIFICATION.	

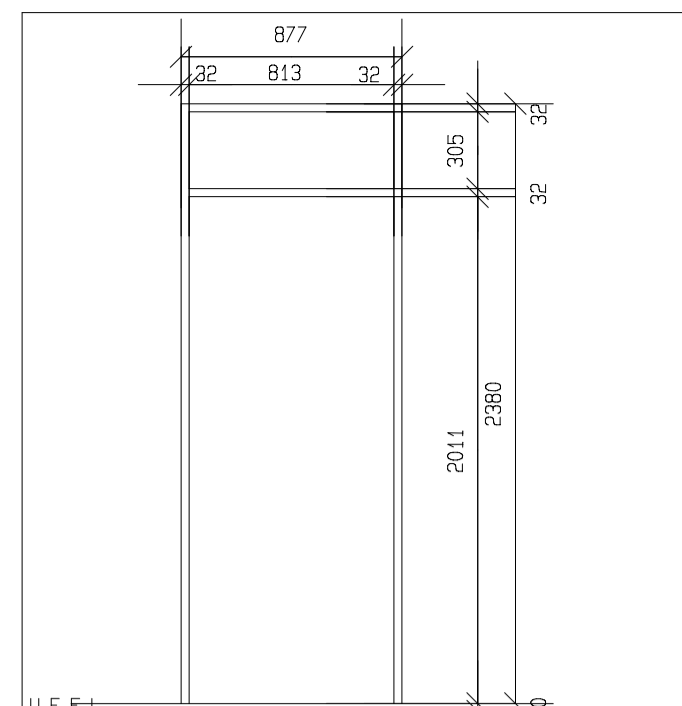

DOOR NO.	D2	NUMBER REQD.
FRAME DESCRIPTION	EXISTING STANDARD 1.2mm THICK SINGLE REBATE MILD STEEL DOOR FRAME COMPLETE WITH ONE PAIR STANDARD BUTT HINGES. FOR 115mm OR 230mm WALL.	
FRAME FINISHING	SAND DOWN EXISTING FRAME AND APPLY COATS POLYURETHANE ENAMEL. SANDPAPER LIGHTLY BETWEEN COATS. COLOUR ACCORDING TO ARCHITECT.	
DOOR DESCRIPTION	NEW 2032x813x40mm THICK SEMI-SOLID CORE DOOR WITH 3mm THICK TEMPERED HARDBOARD SIDES AND CONCEALED HARDWOOD EDGES.	
DOOR FINISHING	PREPARE AND CLEAN. APPLY ONE COAT WOOD PRIMER AND TWO COATS POLYURETHANE VELVET ENAMEL. SANDPAPER LIGHTLY BETWEEN COATS. COLOUR ACC. TO ARCHITECT.	
FANLIGHT	4mm THICK FLOAT GLASS IN PUTTY IN FRAME.	
IRONMONGERY AND SUNDRIES	SEE SPECIFICATION.	

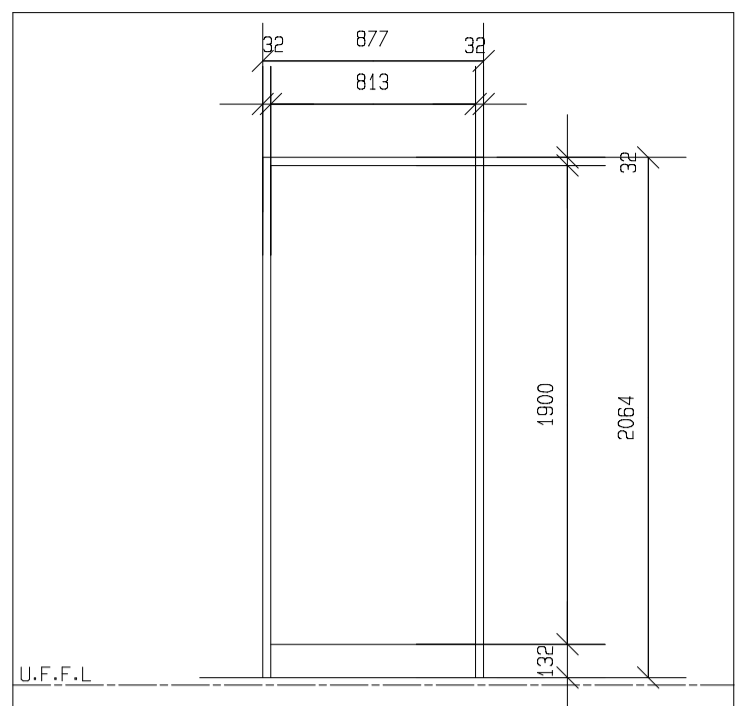

DOOR NO.	D3	NUMBER REQD.
FRAME DESCRIPTION	EXISTING STANDARD 1.2mm THICK SINGLE REBATE MILD STEEL DOOR FRAME COMPLETE WITH ONE PAIR STANDARD BUTT HINGES. FOR 115mm WALL.	
FRAME FINISHING	SAND DOWN EXISTING FRAME AND APPLY COATS POLYURETHANE ENAMEL. SANDPAPER LIGHTLY BETWEEN COATS. COLOUR ACCORDING TO ARCHITECT.	
DOOR DESCRIPTION	NEW 1906x813x40mm THICK SEMI-SOLID CORE DOOR WITH 3mm THICK TEMPERED HARDBOARD SIDES AND CONCEALED HARDWOOD EDGES. GAP OF 1032mm AT BOTTOM.	
DOOR FINISHING	PREPARE AND CLEAN. APPLY ONE COAT WOOD PRIMER AND TWO COATS POLYURETHANE VELVET ENAMEL. SANDPAPER LIGHTLY BETWEEN COATS. COLOUR ACCORDING TO ARCHITECT.	
FANLIGHT	NONE.	
IRONMONGERY AND SUNDRIES	SEE SPECIFICATION.	

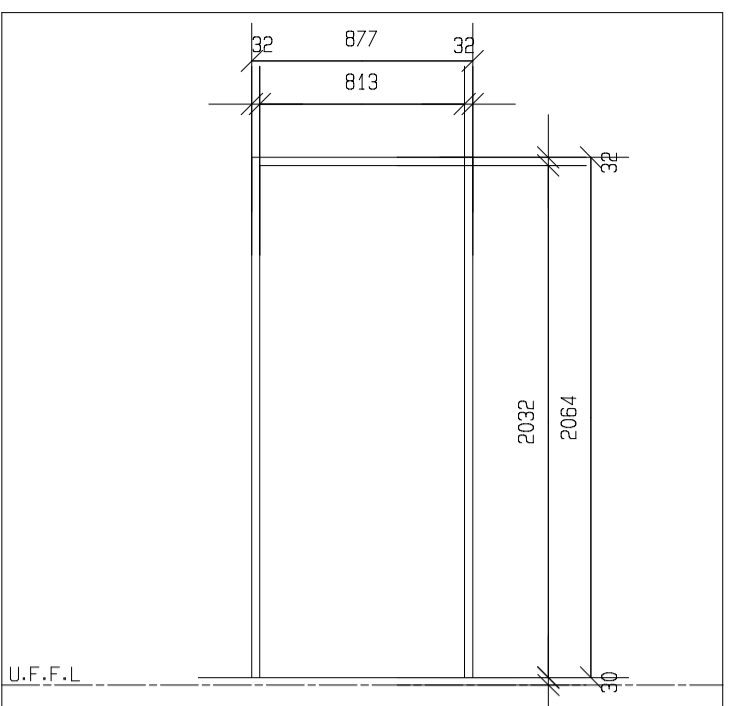

DOOR NO.	D4	NUMBER REQD.
FRAME DESCRIPTION	EXISTING STANDARD 1.2mm THICK SINGLE REBATE MILD STEEL DOOR FRAME COMPLETE WITH ONE PAIR STANDARD BUTT HINGES FOR 345mm WALL. STEEL GATE OPENING OUTWARD.	
FRAME FINISHING	SAND DOWN EXISTING FRAME AND APPLY COATS POLYURETHANE ENAMEL. SANDPAPER LIGHTLY BETWEEN COATS. COLOUR ACCORDING TO ARCHITECT.	
DOOR DESCRIPTION	NEW 2032x813x40mm THICK SOLID CORE DOOR WITH 3mm THICK TEMPERED HARDBOARD SIDES AND CONCEALED HARDWOOD EDGES.	
DOOR FINISHING	PREPARE AND CLEAN. APPLY ONE COAT WOOD PRIMER AND TWO COATS POLYURETHANE VELVET ENAMEL. SANDPAPER LIGHTLY BETWEEN COATS. COLOUR ACCORDING TO ARCHITECT.	
FANLIGHT	NONE.	
IRONMONGERY AND SUNDRIES	SEE SPECIFICATION.	

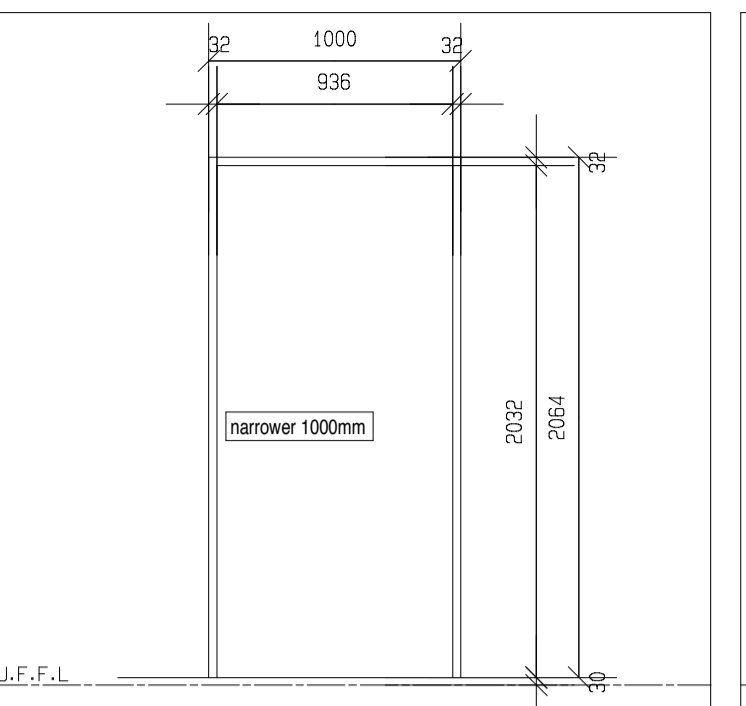

DOOR NO.	D5	NUMBER REQD.
FRAME DESCRIPTION	EXISTING STANDARD 1.2mm THICK SINGLE REBATE MILD STEEL DOOR FRAME COMPLETE WITH ONE PAIR STANDARD BUTT HINGES FOR 345mm WALL.	
FRAME FINISHING	SAND DOWN EXISTING FRAME AND APPLY COATS POLYURETHANE ENAMEL. SANDPAPER LIGHTLY BETWEEN COATS. COLOUR ACCORDING TO ARCHITECT.	
DOOR DESCRIPTION	NEW 1000x813x40mm THICK SOLID CORE DOOR WITH 3mm THICK TEMPERED HARDBOARD SIDES AND CONCEALED HARDWOOD EDGES.	
DOOR FINISHING	PREPARE AND CLEAN. APPLY ONE COAT WOOD PRIMER AND TWO COATS POLYURETHANE VELVET ENAMEL. SANDPAPER LIGHTLY BETWEEN COATS. COLOUR ACCORDING TO ARCHITECT.	
FANLIGHT	NONE.	
IRONMONGERY AND SUNDRIES	SEE SPECIFICATION.	

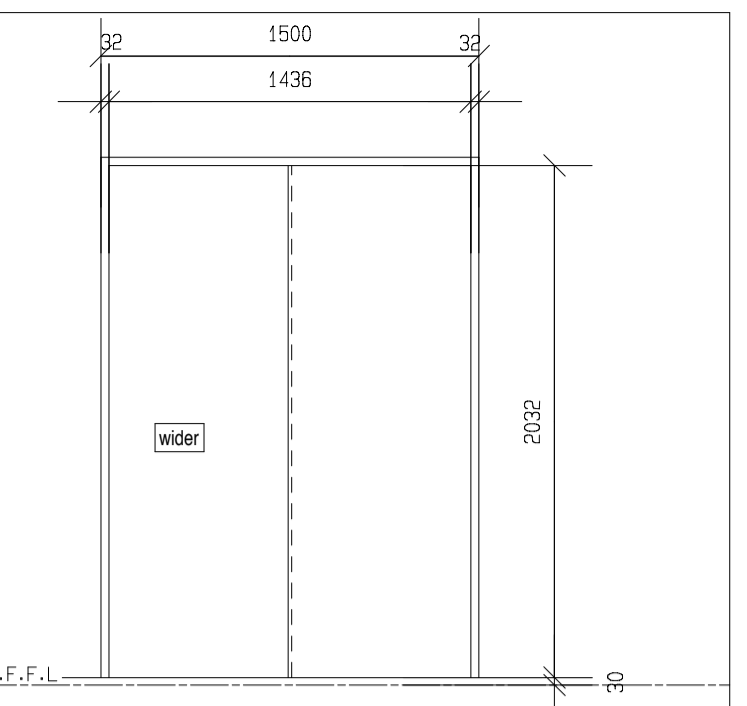

DOOR NO.	D6	NUMBER REQD.
FRAME DESCRIPTION	EXISTING STANDARD 1.2mm THICK SINGLE REBATE MILD DOUBLE STEEL DOOR FRAME COMPLETE WITH ONE PAIR STANDARD BUTT HINGES. FOR 230mm WALL.	
FRAME FINISHING	SAND DOWN EXISTING FRAME AND APPLY COATS POLYURETHANE ENAMEL. SANDPAPER LIGHTLY BETWEEN COATS. COLOUR ACCORDING TO ARCHITECT.	
DOOR DESCRIPTION	NEW 2032x1500x40mm THICK SOLID CORE DOUBLE DOORS WITH 3mm THICK TEMPERED HARDBOARD SIDES AND CONCEALED HARDWOOD EDGES AND REBATED SLAMMING STYLES.	
DOOR FINISHING	PREPARE AND CLEAN. APPLY ONE COAT WOOD PRIMER AND TWO COATS POLYURETHANE VELVET ENAMEL. SANDPAPER LIGHTLY BETWEEN COATS. COLOUR ACCORDING TO ARCHITECT. 4mm THICK CLEAR FLOAT GLASS VIEWING PANEL 300x900mm with 19mm WOOD GLAZING BEADS. 4mm FLOAT GLASS IN PUTTY IN FANLIGHT.	
FANLIGHT	NONE.	
IRONMONGERY AND SUNDRIES	SEE SPECIFICATION.	

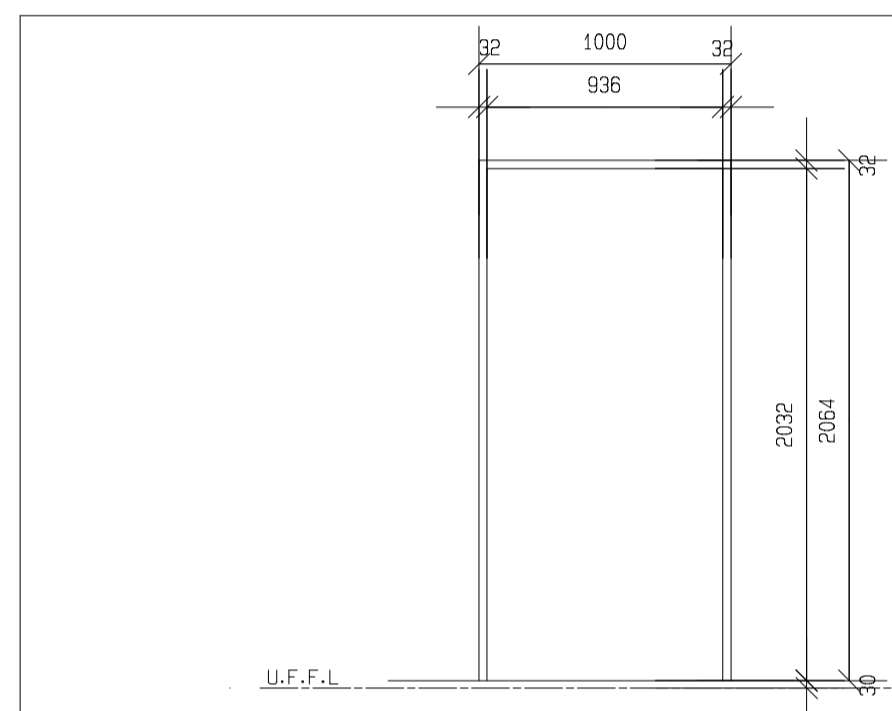

DOOR NO.	D7	NUMBER REQD.
FRAME DESCRIPTION	NONE.	
FRAME FINISHING	NO ACTION.	
DOOR DESCRIPTION	NEW 2032x1000x40mm THICK SOLID CORE DOOR WITH 3mm THICK TEMPERED HARDBOARD SIDES AND CONCEALED HARDWOOD EDGES. SUSPENDED FROM EXISTING SLIDING MECHANISM.	
DOOR FINISHING	PREPARE AND CLEAN. APPLY ONE COAT WOOD PRIMER AND TWO COATS POLYURETHANE VELVET ENAMEL. SANDPAPER LIGHTLY BETWEEN COATS. COLOUR ACCORDING TO ARCHITECT.	
FANLIGHT	NONE.	
IRONMONGERY AND SUNDRIES	SEE SPECIFICATION.	

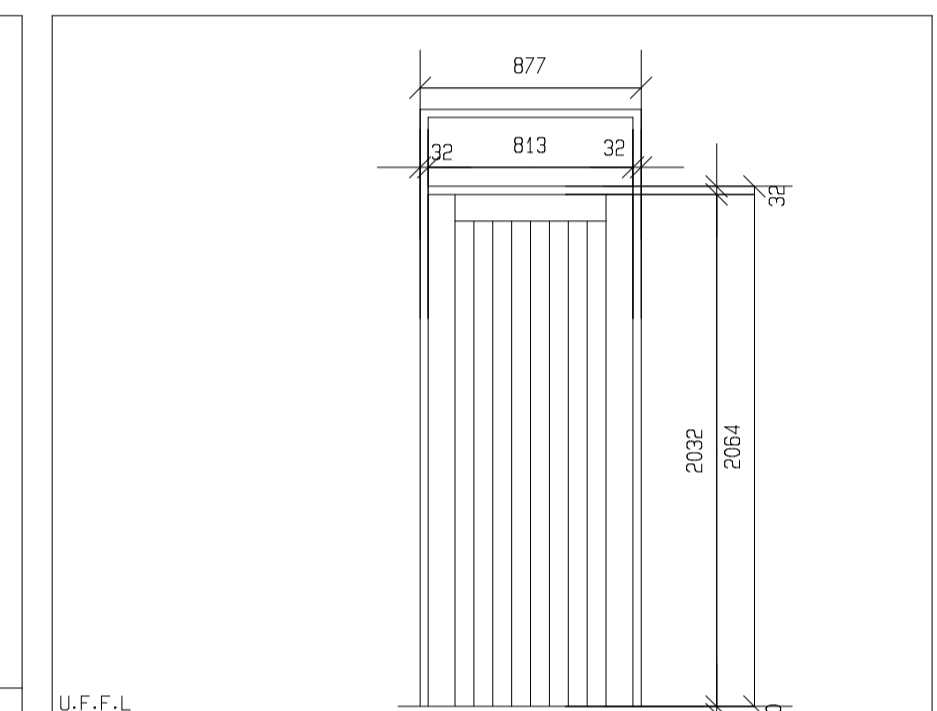

DOOR NO.	D8	NUMBER REQD.
FRAME DESCRIPTION	STANDARD 1.2mm THICK SINGLE REBATE MILD STEEL DOOR FRAME FOR 230mm WALL. FRAME COMPLETE WITH ONE PAIR STANDARD BUTT HINGES.	
FRAME FINISHING	SAND DOWN. APPLY TWO COATS POLYURETHANE ENAMEL. SANDPAPER LIGHTLY BETWEEN COATS. COLOUR ACCORDING TO ARCHITECT.	
DOOR DESCRIPTION	2032x813x40mm THICK T&G FRAMED LEDGED AND BATTEN MERANTI DOOR WITH REBATE FLUSH PANEL INSIDE. SUPPLY STANDARD WEATHER BAR.	
DOOR FINISHING	INTERNAL: PREPARE AND CLEAN. APPLY TWO COATS POLYURETHANE VARNISH. SANDPAPER LIGHTLY BETWEEN COATS. EXTERNAL: PREPARE AND CLEAN. APPLY TWO COATS F.P.R. WOODSHIELD.	
FANLIGHT	NONE.	
IRONMONGERY AND SUNDRIES	SEE SPECIFICATION.	

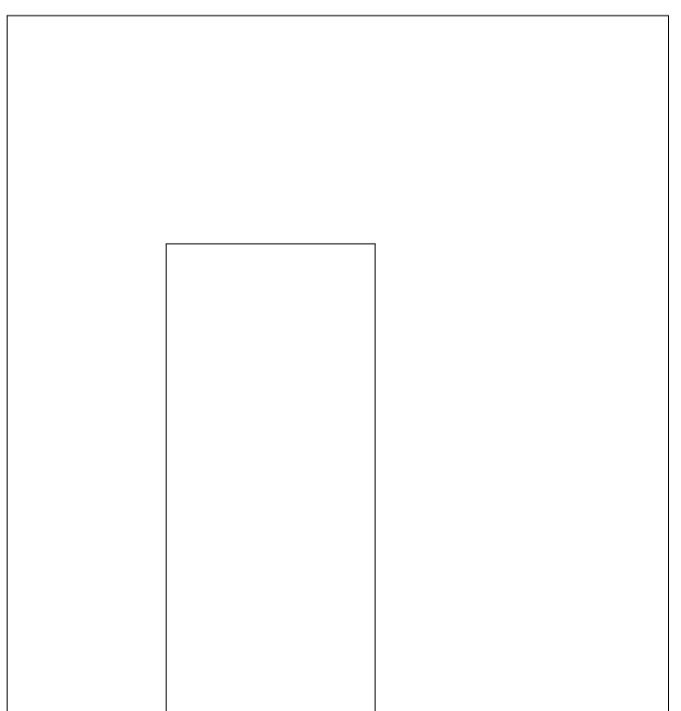

DOOR NO.	D9	NUMBER REQD.
FRAME DESCRIPTION	MUTUAL DS1 6mm RECORDROOM DOOR +/-230kg COMPLETE WITH 7 BOLTS OF 30mm DIA. AND 7 LEVER SECURITY KEYLOCK. INSTALLED STRICTLY ACCORDING TO MANUFACTURER'S SPECIFICATION. FINISH: FACTORY APPLIED PRIMER. PREPARE AND CLEAN. APPLY ONE COAT UNIVERSAL UNDERCOAT AND TWO COATS POLYURETHANE ENAMEL. SANDPAPER LIGHTLY BETWEEN COATS. COLOUR ACCORDING TO ARCHITECT.	
FRAME FINISHING	SAND DOWN. APPLY TWO COATS POLYURETHANE ENAMEL. SANDPAPER LIGHTLY BETWEEN COATS. COLOUR ACCORDING TO ARCHITECT.	
DOOR DESCRIPTION	2032x813x40mm THICK T&G FRAMED LEDGED AND BATTEN MERANTI DOOR WITH REBATE FLUSH PANEL INSIDE. SUPPLY STANDARD WEATHER BAR.	
DOOR FINISHING	INTERNAL: PREPARE AND CLEAN. APPLY TWO COATS POLYURETHANE VARNISH. SANDPAPER LIGHTLY BETWEEN COATS. EXTERNAL: PREPARE AND CLEAN. APPLY TWO COATS F.P.R. WOODSHIELD.	
FANLIGHT	NONE.	
IRONMONGERY AND SUNDRIES	SEE SPECIFICATION.	

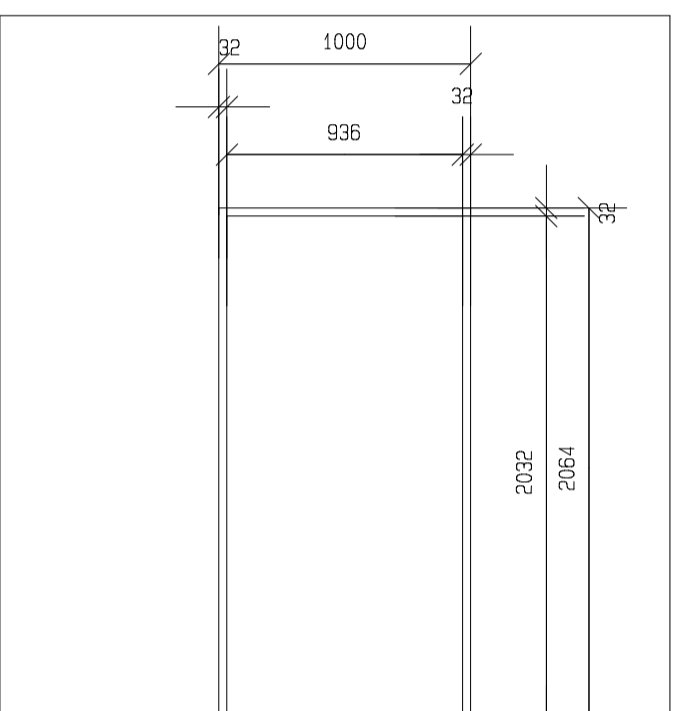

DOOR NO.	D10	NUMBER REQD.
FRAME DESCRIPTION	NONE.	
FRAME FINISHING	NO ACTION.	
DOOR DESCRIPTION	NEW 2032x1000x40mm THICK SOLID CORE DOOR WITH 3mm THICK TEMPERED HARDBOARD SIDES AND CONCEALED HARDWOOD EDGES. SUSPENDED FROM EXISTING SLIDING MECHANISM.	
DOOR FINISHING	PREPARE AND CLEAN. APPLY ONE COAT WOOD PRIMER AND TWO COATS POLYURETHANE VELVET ENAMEL. SANDPAPER LIGHTLY BETWEEN COATS. COLOUR ACCORDING TO ARCHITECT.	
FANLIGHT	NONE.	
IRONMONGERY AND SUNDRIES	SEE SPECIFICATION.	

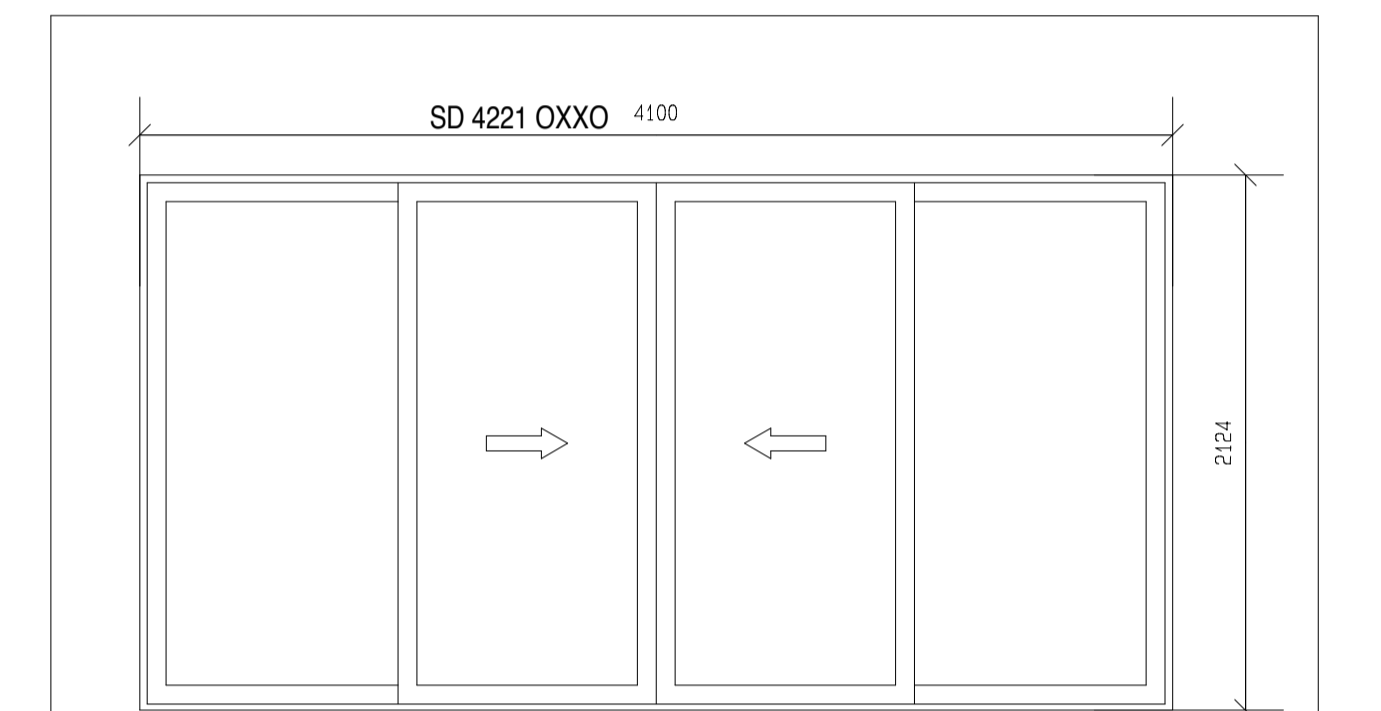

DOOR NO.	W7	NUMBER REQD.
FRAME DESCRIPTION	NONE.	
FRAME FINISHING	NO ACTION.	
DOOR DESCRIPTION	NEW 2032x1000x40mm THICK SOLID CORE DOOR WITH 3mm THICK TEMPERED HARDBOARD SIDES AND CONCEALED HARDWOOD EDGES. SUSPENDED FROM EXISTING SLIDING MECHANISM.	
DOOR FINISHING	PREPARE AND CLEAN. APPLY ONE COAT WOOD PRIMER AND TWO COATS POLYURETHANE VELVET ENAMEL. SANDPAPER LIGHTLY BETWEEN COATS. COLOUR ACCORDING TO ARCHITECT.	
FANLIGHT	NONE.	
IRONMONGERY AND SUNDRIES	SEE SPECIFICATION.	

- GENERAL NOTES**
- All general notes apply to all drawings, details, specifications & any supplementary information: all contractual documentation.
 - The contractor is responsible for checking all levels & dimensions on site when setting out, prior to commencing construction & cross checking all building dimensions during the construction process. Read only figured dimensions, indicated in millimetres, & do not scale. Any discrepancies are to be reported in writing to DPWL prior to continuation of work.
 - The contractor is responsible for the works co-ordination & programming of the works. All consultant & shop drawings are to be cross checked with DPWL drawings. Any discrepancies are to be reported in writing to DPWL prior to continuation of work.
 - The contractor is responsible for reporting any deviation from DPWL drawings & specifications. Written approval is required from edifice design prior to construction & installation commencing.
 - DPWL accepts no responsibility for errors resulting from the misinterpretation of drawings or specifications. If in doubt, query details.
 - The contractor is responsible for: compliance with all applicable SABS 0400 standards, manufacturer's installation instructions, procedures & recommendations & local authority regulations in respect of the full scope of the works. This requirement shall not be deemed to be superseded by the provisions of any other contract document.
 - The contractor is responsible for construction procedures & methodology being carried out & implemented in strict accordance with the latest occupational health & safety act & regulations.
 - The contractor is responsible for checking all opening sizes & vertical & horizontal position prior to the construction, manufacture & installation of fitted items. Any discrepancies are to be reported in writing to DPWL prior to continuation of work.
 - The contractor is responsible for the provision of guarantees for all materials, installations & systems, to be issued to DPWL at practical completion.
 - All structural work is to be designed, detailed, specified & supervised by the structural engineer & is to be carried out in strict accordance with this. All structural work is to be built from the engineer's drawings and the stability is to be certified by the structural engineer on completion of the works.
 - Drawings are only to be read for the purpose intended.
 - Refer to project data sheet for comprehensive notes & specifications.

DOOR AND WINDOWS:
All external doors and windows to have aluminium frames as per SABS specifications. Internal doors to be flush panel semi-solid with hardwood frames provided with one pair 100mm brass butt hinges and lock set. Windows glazing to be in accordance with NBR. Bathroom and WC windows to be obscure.

GLAZING:
All Glazing unless specified Clear laminated sound control safety glass, complying with SANS 1263 Part 1, 2 or 3 with name of the manufacturer permanently marked on each sheet visible after glazing, glazed in accordance with NBR N schedule 1 and SABS 0137.

Glass Properties:

- Shading Coefficient = 0.47 to 0.70
- Light Transmission Level = 61 to 95

Specified: Obscure glazed unit, glazed in accordance with NBR N schedule 1 and SABS 0137.

Glass Properties:

- Shading Coefficient = 0.58 to 0.75
- Light Transmission Level = 59 to 83

EXTERNAL WORKS:
ALL Paving to be laid on well compacted AND consolidated ground to engineer's detail. Soil poisoning shall be provided under paving in accordance to Engineer's specifications.

CONCRETE:
All proposed and existing concrete works, paving AND storm water reticulation to be specified, verified and approved by engineer.

PLASTER:
Internal plaster to be 10 to 15mm thick, cement /sand ratio of 1:5 plaster sealed, 1 undercoat, 2 coats 'wall n all' paint. Colour to be approved.

EXPANSION JOINTS:
Expansion (control) joints where deemed necessary by engineer to be formed with a continuous strip of 12mm bitumen impregnated soft-board between 230mm brick walls. To be sealed internally and externally with 10mm deep polysulphide sealant.

INSULATION:
50mm Alutherm AP polyester fibre blanket laminated to 4mm white bubble layer on one side and reinforced foil facing on other, complying with SANS 1381-1:2007, laid and stapled horizontally on top of timber rafters and bracing before fixing of roof sheeting (elsewhere specified).

COPYRIGHT
In accordance with the relevant clauses of the Copyright Act (Act 98 of 1978) relating to assignment, all documents prepared by DPWL in connection with the project remain the property and copyright of DPWL, subject to their use by the client for the particular project to which this document relates, and the client shall not be entitled, either directly or indirectly, to make use of the document(s) for any additional or similar works or publish the same except with the prior consent from DPWL.

REV NO.	DATE	REVISION

DEPARTMENT

 DEPARTMENT OF
PUBLIC WORKS, ROADS & INFRASTRUCTURE
 Limpopo Department of Public Works, Roads and Infrastructure's Strategic Planning and Design Hub.
 43 Church Street, Polokwane, 0700
 (015) 284 7000/1

PROJECT TITLE
 MASIA: TRIBAL OFFICE FOR THE DEPARTMENT OF TRADITIONAL AFFAIRS

DRAWING TITLE
 DOOR SCHEDULE

SCALE	N/A	DRAWN	T.CELE	
DATE	14_08_2018	CHECKED	T.CELE	
SIZE	PROJECT NO.	STAGE	DRAWING NO.	REV.
A1	TO_19000	C	TO_19000_200	0

FOR CONSTRUCTION